

TECHNICAL REPORT



June 10,
2018

Update of Equipment, Component and Fugitive Emission Factors for Alberta Upstream Oil and Gas.

Prepared For: Alberta Energy Regulator
Suite 1000, 250 – 5 Street SW
Calgary, Alberta T2P 0R4

Prepared by: Clearstone Engineering Ltd.
700, 900-6th Avenue S.W.
Calgary, AB, T2P 3K2

and Carleton University
1125 Colonel By Drive
Ottawa, ON, K1S 5B6

Contact: Yori Jamin, M.Sc., P.Eng.
Telephone: 403-215-2733
E-mail: yori.jamin@clearstone.ca

DISCLAIMER

While reasonable effort has been made to ensure the accuracy, reliability and completeness of the information presented herein, this report is made available without any representation as to its use in any particular situation and on the strict understanding that each reader accepts full liability for the application of its contents, regardless of any fault or negligence of Clearstone Engineering Ltd.

EXECUTIVE SUMMARY

This report describes the field campaign conducted at Alberta upstream oil and natural gas (UOG) sites from 14 August to 23 September 2017 and methodology applied to determine average factors and confidence intervals for the following parameters.

- Process equipment count per facility subtype¹ or well status code².
- Component count per process equipment unit³.
- Emission control type per process equipment unit.
- Pneumatic device count per facility subtype or well status code by device and driver types.
- Leak rate per component and service type⁴ considering the entire population of components with the potential to leak (i.e., ‘population average’ factor).
- Leak rate per component and service type considering leaking components only (i.e., ‘leaker’ factor).

The study was completed under the authority of the Alberta Energy Regulator (AER) and funded by Natural Resources Canada (NRCan) with the objective of improving confidence in methane emissions from Alberta UOG fugitive equipment leaks, pneumatic devices and reciprocating rod-packings. Results are intended for an emission inventory model used to predict equipment/component counts, uncertainties and air emissions associated with UOG facility and well identifiers.

Fugitive equipment leaks and pneumatic venting sources are targeted by this study because they contribute approximately 17 and 23 percent, respectively, of methane emissions in the 2011 national inventory (ECCC, 2014) and are based on uncertain assumptions regarding the population of UOG equipment and components. Moreover, a 2014 leak factor update report published by the Canadian Association of Petroleum Producers (CAPP) recommended equipment and component counts be refined based on field inventories and standardized definitions because of limitations encountered when determining these from measurement schematics, process flow diagrams (PFD) or piping and instrumentation diagrams (P&ID) (CAPP, 2014 sections 4.1.1 and 4.2.1).

1 Facility subtypes are defined in Table 2 of [AER Manual 011](#) (AER, 2016b).

2 Well status codes are defined by the four category types: fluid, mode, type and structure.

3 Process equipment units are defined in Appendix Section 8.4.

4 Component types and service types are defined in Appendix Sections 8.2 and 8.3.

Scope

The scope of this study targets UOG wells, multi-well batteries, and compressor stations belonging to AER facility subtypes contributing the most to UOG methane emission uncertainty. Larger UOG facilities and oil sands operations are specifically excluded from this study because they are often subject to regulated emission quantification, verification and compliance requirements that motivate accurate, complete and consistent methane emission reporting.

The field sampling plan follows the fugitive emission measurement protocol recommended by the Canadian Energy Partnership for Environmental Innovation (CEPEI, 2006) with the optical gas imaging (OGI) method used for leak detection. The field campaign targeted UOG wells, multi-well batteries, and compressor stations belonging to the following UOG industry segments (and AER facility subtypes) contributing the most to UOG methane emission uncertainty. Candidate sample locations were randomly selected from subtype populations with surveys completed at as many sites as budgeted resources allowed.

- Natural Gas Production (subtypes 351, 361, 362, 363, 364, 365, 366, 367, 601, 621 & 622)
- Light and Crude Oil Production (subtypes 311, 321 and 322)
- Cold Heavy Crude Oil Production (subtypes 331, 341, 342, 343 and 611)

Data collection and leak surveys were completed at 333 locations, operated by 63 different companies, and included 241 production accounting reporting entities and 440 UWIs. This sample data represents the vintage, production characteristics and regulatory oversight corresponding to UOG facilities operating in Alberta during 2017. The geographic distribution of survey locations is illustrated in Figure ES-1.

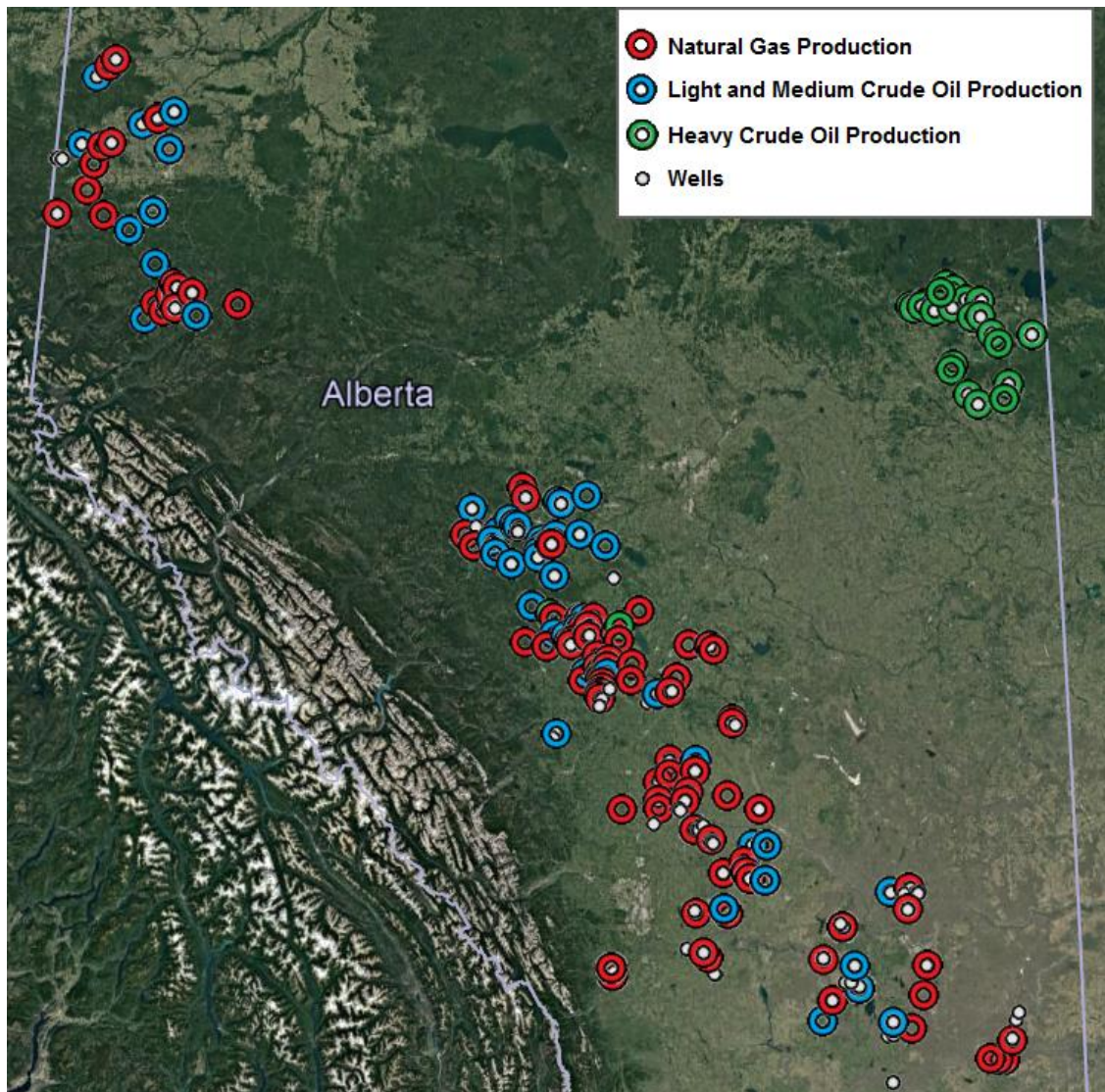

Figure ES-1: Survey locations and facility subtypes for the 2017 measurement campaign.

Data Collection and QA/QC

Field measurements and data collection was led by Greenpath Energy Ltd. (Greenpath). Greenpath technicians were paired with an AER inspector or a Clearstone engineer to enhance field team depth with respect to regulatory inspections and process knowledge. Before beginning the campaign, all field team members attended three days of project-specific desktop and field training. Standardized data collection methods and strict definitions for component, equipment, service, emission and facility type are documented in the sampling plan and used by field teams. Other quality assurance (QA) measures implemented to ensure reliable field data included:

- Use of leak detection and measurement equipment appropriate for the site conditions and source characteristics encountered at UOG facilities. Equipment is regularly serviced and maintained in accordance with the manufacturer’s specifications.

- Field observations were documented in a complete and consistent manner using a software application designed for this project. The application was installed on tablets and pre-populated with site identifiers and standard definitions that enabled selection from drop-down menus (instead of free-form data entry).
- Photos were taken of each site placard (to confirm surveyed locations) and each equipment unit (to confirm the correct equipment type was selected and reasonable component counts were completed).
- Infrared (IR) camera videos were recorded to confirm the component type and leak magnitude.
- Tablet data was uploaded to an online repository at the end of each working day to minimize data loss risk (e.g., due to damaged or lost tablets). Backup archive files were checked at the end of the field campaign to confirm no data leakage occurred.
- Parsing of tablet records into an SQL database was automated to minimize processing time and transcription errors.

The data collected was tested according to the following quality control (QC) procedures:

- Records were reviewed by the field team coordinator on a daily basis to identify and mitigate data collection errors. When observed, problematic records were corrected and communicated to the entire field team to prevent future occurrences.
- The possibility of data leakage between the field tablets and final SQL database was checked by comparing tablet archives to final database records.
- Site placard photos, equipment photos, IR videos and measurement schematics were used during post survey processing to determine the validity of data outliers.
- Various post-processing statistical tests and quality control checks were performed on the data to ensure records are correctly classified and representative of process conditions.
- Raw data records were provided to the operator of each site surveyed. Written feedback regarding data corrections were received from five operators and refinements made to the dataset.

Observational and measurement data are assigned to corresponding AER facility and well identifiers based on measurement schematics provided by subject operators. Field observations are correlated to Facility IDs and UWIs so that the resulting factors are representative and applicable to the AER regulated UOG industry managed with [Petrinex](#) data models.

Uncertainty Analysis

It is good practice to evaluate the uncertainties in all measurement results and in the emission calculation parameters derived from these results. Quantification of these uncertainties ultimately facilitates the prioritization of efforts to improve the accuracy of emissions inventories developed using these data. Measurement uncertainty arises from inaccuracy in the measuring equipment,

random variation in the quantities measured and approximations in data-reduction relations. These individual uncertainties propagate through the data acquisition and reduction sequences to yield a final uncertainty in the measurement result. Two types of uncertainties are encountered when measuring variables: systematic (or bias) and random (or precision) uncertainties (Wheeler and Ganji, 2004). Confidence intervals for study results are determined using the bootstrapping method and adopt the IPCC (2000) Good Practice Guidance suggestion to use a 95% confidence level (i.e., the interval that has a 95% probability of containing the unknown true value) and Tier 1 rules for error propagation.

Bootstrapping is a statistical resampling method which is typically used to estimate population variables/parameters from empirically sampled data (Efron, and Tibshirani, 1993). Bootstrapping as a method is non-parametric and does not rely on common assumptions such as normality, data symmetry or even knowledge of the data's underlying distribution. It is applied by other studies investigating 'heavy-tailed' leak distributions and is shown to increase the width of confidence intervals by increasing the upper bound (Brandt et al, 2016). The one main underlying assumption behind bootstrapping, for the results to be reliable, is that the sample set is representative of the population.

Results for Process Equipment and Components

Process equipment and components (greater than 0.5" NPS) in pressurized hydrocarbon service were counted and classified according to standardized definitions presented in Appendix Section 8. Equipment and component schedules are used to estimate the number of potential hydrocarbon vapour leak sources exist in the Alberta UOG industry. Process equipment and components entirely in water, air⁵, lubricating oil and non-volatile chemical service were **not** included in the inventory because they are less likely to emit hydrocarbons. Factors representing the average (mean) number of equipment units per facility subtype or well status are calculated by dividing the total equipment count by the total number of sites surveyed for each of the strata considered. Average counts and confidence intervals are determined for 27 process equipment types observed at 11 facility subtypes and 12 well status codes. Results for facility subtypes are presented in Table 3 of the report body while results for well status codes are in Table 4.

In addition to counting components, the following emission controls were noted by field inspectors when installed on subject process equipment units.

- Gas Conserved – where natural gas is captured and sold, used as fuel, injected into reservoirs for pressure maintenance or other beneficial purpose.
- Gas tied to flare – where natural gas is captured and disposed by thermal oxidization in a flare or incinerator.

⁵ Pneumatic devices driven by instrument air were inventoried as discussed in Section 3.4. The air compressor and piping were not inventoried.

- Gas tied to scrubber – where natural gas is captured and specific substances of concern (e.g., H₂S or other odourous compounds) are removed via adsorption or catalytic technologies.

Average emission control per subject equipment units are presented in Table ES-1. These results consider the frequency controls are observed and the estimated control efficiency for preventing the release of natural gas to the atmosphere (i.e., how much of the subject gas stream is captured and combusted/conserved over an extended period of time). Because control efficiency assessment was beyond the scope of the 2017 field campaign, a conservative estimate of 95 percent is adopted for conservation and flaring (from CCME, 1995⁶) while scrubbers are assigned 0 control because they prevent very little of subject natural gas streams from being released to atmosphere.

Description of Control	Process Equipment Count	Control Count	Average Control Factor	95% Confidence Interval (%of mean)	
				Lower	Upper
Storage tank tied into flare or conserved	213	46	0.21	28%	31%
Storage tank tied into scrubber	213	3	0.00	-	-
Compressor rod-packing vent tied into flare or conserved	54	7	0.12	65%	72%
Pop tank tied into flare or conserved	20	2	0.10	100%	123%

The average (mean) number of components in hydrocarbon process gas or liquid service per process equipment type is calculated for the following component types. Results with confidence intervals are presented in Table 5 of the report body.

- Reciprocating Compressor Rod-Packing,
- Connector,
- Control Valve,
- Meter,
- Open-Ended Line,
- Pressure Relief Valves and Pressure Safety Valves (PRV/PSV),
- Pump Seal,
- Regulator,
- Thief Hatch,
- Valve, and
- Well Surface Casing Vent (SCVF).

⁶ This is the minimum performance required by CCME (1995) for vapour control systems.

A comparison of the 2017 component counts to those derived for the first Canadian UOG “bottom-up” national emission inventory (CAPP, 1992) indicates that the number and diversity of components per equipment type has increased. This is likely driven by increased process measurement/control and liquids-rich gas production introduced over the last 30 years as well as a specific field objective to account for every component in pressurized hydrocarbon service. The 2017 sample plan required inspectors to include all process equipment components plus downstream components until they arrived at the inlet flange of the next process unit. This could include a significant number of components from ‘yard piping’ that are not physically attached to the process unit but are potential leak sources that need to be accounted. For example, the total average number of components for a separator increased 60 percent and now includes control valve, meter, open-ended line, PSV and regulator counts. These changes are reasonable when considering the 3-phase separator shown in Figure ES-2 and commonly used at liquids-rich gas production sites. In addition to the control valve and senior orifice meter visible in Figure ES-2, this separator also features 1 junior orifice meter, 2 turbine meters, 4 regulators (heater and pneumatic pump fuel supply), 1 PSV, 2 chemical injection pumps and numerous pneumatic instruments.

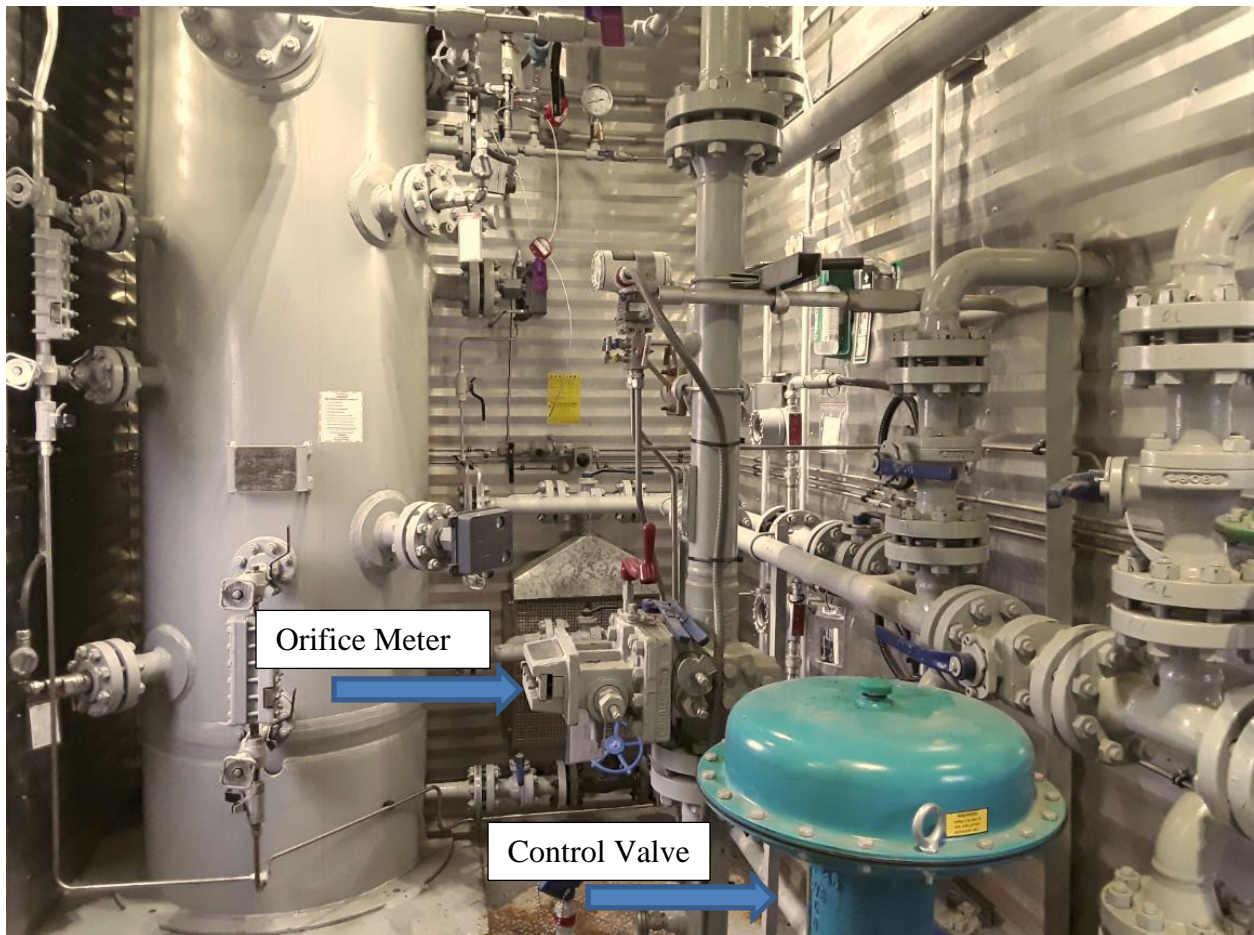

Figure ES-2: Three-Phase vertical separator located at a liquids-rich gas production site.

Results for Pneumatic Devices

Pneumatic devices driven by natural gas, propane, instrument air and electricity were inventoried at each location surveyed in 2017. To increase the sample size, pneumatic inventory data collected in 2016 by Greenpath Energy Ltd. for the AER was considered for this assessment (Greenpath, 2017a). Devices are included in this study when sufficient information was available to assign 2016 records to a Facility ID or UWI (otherwise the data record was discarded). The final dataset includes 1753 devices from the 2017 field campaign plus 1105 devices from the 2016 field campaign.

The average (mean) number of pneumatic devices per facility subtype and well status are presented in the report body Table 7 and Table 8 according to device (e.g., level controllers, positioners, pressure controllers, transducers, chemical pumps and intermittent) and driver type (e.g., instrument air, propane and electric). The factors for natural gas driven devices should be adopted for GHG emission inventory purposes. Factors for propane (relevant to volatile organic compound (VOC) emissions), instrument air and electric driven devices provide some insight into the installation frequency of non-emitting devices. Given the large number of wells and their tendency to rely on natural gas, well-site pneumatics are a noteworthy contributor to total methane emissions in Alberta and deserve careful consideration when developing province-wide emission inventories.

Devices that provide the following control actions are the dominant contributors to pneumatic venting emissions and account for 2,289 of the 2,858 pneumatic devices observed during 2016 and 2017 surveys.

- Level Controller
- Positioner
- Pressure Controller
- Chemical Pump
- Transducer

Figure ES-3 delineates the pneumatic inventory by device type and driver type. The majority of devices are driven by natural gas while approximately 30 percent of devices utilize alternative drivers (instrument air, propane or electricity) that do not directly contribute methane emissions.

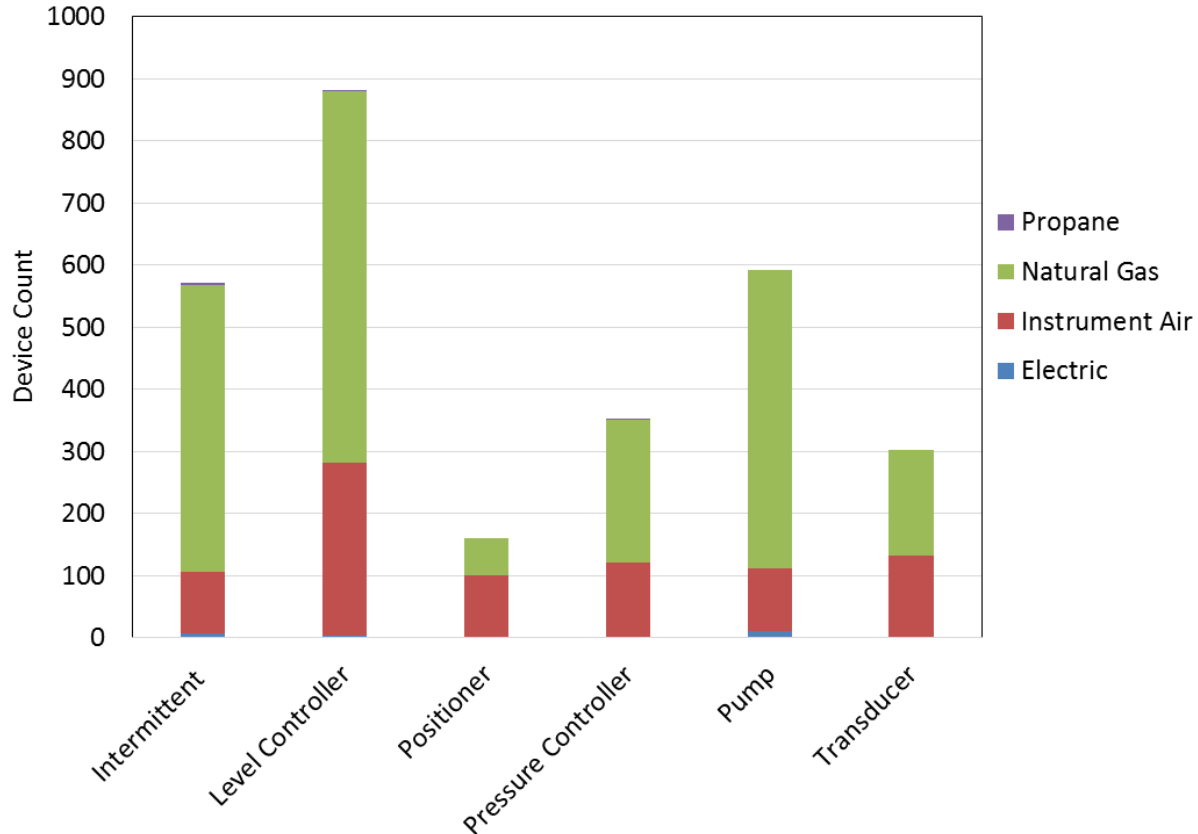

Figure ES-3: Pneumatic counts, by device type and driver type, observed at Alberta UOG facilities and wells during 2016 and 2017 field campaigns.

Devices that provide the following control actions typically vent at rates well below 0.17 m³ per hour or only during infrequent unloading (de-energizing) events. Therefore, subject models are aggregated and presented as device type “Intermittent” in report tables. This simplifies emission inventory development efforts and is reasonable for devices that contributes very little to total methane emissions.

- High Level Shut Down
- High Pressure Shut Down
- Level Switch
- Plunger Lift Controller
- Pressure Switch
- Temperature Switch

Because pneumatic venting rates were not measured during the 2017 and 2016 field campaigns, other studies are relied on to determine vent rates representative of each device type. Emission factors presented in Table ES-2 are a sample-size weighted average of mean bleed rates from

2013 Prasino and 2018 Spartan (Fisher L2 level controller⁷) studies as well as manufacturer specifications for less common models (Prasino, 2013 and Spartan, 2018). The factor labeled ‘generic pneumatic instrument’ includes high and low-bleed instruments that continuously vent. The ‘generic pneumatic instrument’ vent rate of 0.3217 m³/hr is greater than the ‘generic high bleed controller’ vent rate published in the Prasino study (0.2605 m³/hr) largely because of the revised level controller factor published by Spartan (i.e., 0.46 m³/hr ± 22% versus the Prasino factor of 0.2641 m³/hr ± 34%) and the large number of level controllers in the study population. Interestingly, the ‘generic pneumatic instrument’ vent rate is only 9 percent less than the rate applied in the last national inventory (i.e., 0.354 m³/hr in ECCC, 2014). The same isn’t true for chemical pumps, a rate of 0.236 m³/hr was applied in the last national inventory which is 4 times less than the rate presented in Table ES-2.

Device Type	Average Vent Rate (m³ natural gas/hour)	95% Confidence Interval (% of mean)
Level Controller	0.3508	31.68
Positioner	0.2627	39.02
Pressure Controller	0.3217	35.95
Transducer	0.2335	22.54
Generic Pneumatic Instrument	0.3206	31.53
Chemical Pump	0.9726	13.99

Results for Fugitive Emission Factors

Emission factors for estimating fugitive equipment leaks are normally evaluated by type of component and service category within an industry sector. This allows the factors to be broadly applied within the sector provided component populations are known. There are two basic types of emission factors that may be used to estimate emissions from fugitive equipment leaks: those that are applied to the results of leak detection or screening programs (e.g., leak/no-leak and stratified emission factors), and those that do not require any screening information and are simply applied to an inventory of the potential leak sources (i.e., population average emissions factors). Population average emission factors are determined by summing measured leak rates and dividing by the total number of potential leak sources (i.e., components) for each component/service type of interest. End users multiply population average factors by the entire component population in pressurized hydrocarbon service belonging to the facilities/wells of interest.

⁷ Further investigation of level controllers was completed by Spartan (with the support of PTAC) because of concerns that the 2013 Prasino study did not adequately capture emission contributions from the transient state. The mean vent rate from Spartan (0.46 m³/hr ± 22% based on 72 samples) is used to determine level controller rate in Table 16 instead the Prasino factor (0.2641 m³/hr ± 34% based on 48 samples).

“Leaker” emission factors are determined in the same manner but the denominator only includes the number of **leaking** components. End users conduct an OGI survey and multiply the number of leaking components by the corresponding component and service type “leaker” factor. Fugitive emissions estimated using this approach should provide better accuracy and identification of high leak-risk components and facilities than population average factors. However, direct measurement of detected leaks is more accurate and provides valuable insight regarding leak magnitude and frequency distributions that are not available from emission factor approaches. For example, Figure ES-4 indicates that a small number of leaks contribute most of the fugitive emissions for a given component population. The top 10 sites represent most (about 65 percent) of the total leak rate measured during the 2017 campaign with the single largest leak (a SCVF) representing 35 percent of the total leak rate. This is a highly skewed distribution with approximately 16 percent of the leaking components responsible for 80 percent of the total leak rate. This result is consistent with other studies and indicates “super-emitters” are present in the 2017 sample population.

Population average emission factor results are presented on a volume and mass basis in Table ES-3 by component and service type. ‘Leaker’ emissions factors for the same strata are presented in Table ES-4. ‘No-leak’ emission factors are not determined in this study because the High-Flow Sampler method detection limit (MDL) is not sensitive enough to accurately quantify leaks below 10,000 ppmv⁸.

Leak factor results are based on best available OGI survey equipment and technicians currently providing fugitive emission services for the Canadian UOG industry. Notwithstanding this and QAQC efforts, the OGI leak detection and High Flow Sampler measurement methods have limitations that impact the completeness and accuracy of the subject dataset. Thus, a rigorous quantitative uncertainty analysis endeavors to identify and account for all parameters contributing uncertainty to the final emission factors. 2017 confidence limits are generally greater than historic values primarily because of the following contributions that were acknowledged but underestimated in historic results (CAPP, 2005 and CAPP, 2014).

- Uncertainty in component counts due to field technician variability and bias.
- Uncertainty that all leaks are detected by the OGI survey method.

Exceptions where 2017 confidence limits are less than those presented in CAPP, 2014 occur for components with large no-leak contributions (e.g., connectors, PRV, pump seals and valves). The 2014 assessment assigned a very large upper confidence limit to no-leak factors (500 percent) which strongly influences population average confidence limits for components with

⁸ Ideally, no-leak emission factors would be developed using an instrument with precision of 1 ppm, MDL of about 2 ppm above background readings and measurement uncertainty of less than ±1% of reading.

large no-leak contributions. Whereas, no-leak contributions are not included in 2017 population average factors. Moreover, no-leak contributions should be calculated as a separate category when estimating fugitive emissions. When no-leak emission factors are multiplied by the population of components surveyed in 2017, it's estimated that leakage occurring below OGI and High-Flow MDLs is responsible for approximately 38 percent of total equipment leak emissions.

Comparison of 2017 Leak Results with Historic Fugitive Studies

The implications of 2017 emission factors on total fugitive emissions is estimated by multiplying the component population surveyed in 2017 by population average leak factors from two reference studies: 2014 CAPP *Update of Fugitive Emission Equipment Leak Emission Factors* and 2005 CAPP *National Inventory of GHG, CAC and H₂S Emissions by the Upstream Oil and Gas Industry*. A comparison of results indicates 2017 and 2014 factors generate about the same total fugitive emissions which are approximately 60 percent less than those generated using 2005 factors.

Reciprocating Compressor Rod-Packing Leakage Rates Expected by Manufacturers

The largest manufacturer of reciprocating gas compressors indicates typical leakage rates for packing rings in good condition range from 0.17 m³ to 0.29 m³ per hour per rod-packing while the 'alarm' point for scheduling maintenance ranges from 2.9 m³ to 5.8 m³ per hour per rod-packing (Ariel, 2018). The probable population average leak rate for rod-packings is 0.2875 m³ THC per hour per rod-packing (with lower and upper confidence limits of 0.1361 and 0.5415 m³ THC per hour). Thus, reciprocating compressors surveyed in 2017 typically vent within manufacturer tolerances for packing rings in good condition. The upper confidence limit is much less than the maintenance alarm threshold of 2.9 m³ per hour. Only two measurement records were greater than 2.9 m³ per hour but because rod-packings vent into a common header, it's not known whether the emissions were dominated by one or multiple rod-packings.

Table ES-3: Population average emission factors for estimating fugitive emissions from Alberta UOG facilities on a volume^a or mass basis.

Sector	Component Type	Service	Leaker Count	Component Count	Leak Frequency	EF (kg THC /h/source)	95% Confidence Limit (% of mean)		EF (m ³ THC /h/source)	95% Confidence Limit (% of mean)	
							Lower	Upper		Lower	Upper
All	Compressor Rod-Packing ^{b,c}	PG		139		0.20622	53%	88%	0.28745	53%	88%
All	Connector	PG	145	137,391	0.11%	0.00014	32%	53%	0.00019	32%	52%
All	Connector	LL	6	45,356	0.01%	0.00001	71%	114%	0.00001	70%	120%
All	Control Valve	PG	16	539	2.97%	0.00487	53%	77%	0.00646	53%	77%
All	Meter	PG	8	531	1.51%	0.00105	47%	73%	0.00145	47%	70%
All	Open-Ended Line	PG	10	144	6.95%	0.06700	91%	219%	0.09249	91%	225%
All	Pressure Relief Valve	PG	7	1,176	0.60%	0.00399	54%	85%	0.00552	53%	79%
All	Pump Seal	PG	6	178	3.37%	0.00761	73%	142%	0.01057	73%	141%
All	Regulator	PG	27	3,067	0.88%	0.00112	60%	99%	0.00122	50%	76%
All	Thief Hatch	PG	6	52	11.46%	0.12870	77%	134%	0.12860	70%	115%
All	Valve	PG	28	20,545	0.14%	0.00044	64%	112%	0.00058	62%	111%
All	Valve	LL	6	8,944	0.07%	0.00015	72%	122%	0.00021	73%	120%
All	SCVF	PG	15	440	3.41%	0.09250	98%	204%	0.12784	98%	196%

^a Volumes are presented at standard reference conditions of 15°C and 101.325 kPa.

^b Reciprocating compressor rod-packing emission factors are calculated on a per rod-packing basis and exclude compressors that are tied into a flare or VRU (because these rod-packings are controlled and have a very low probability of ever leaking to atmosphere). Rod-packings are defined as vents in Directive 060 (AER, 2018).

^c Reciprocating Compressor rod-packings vents are typically tied into a common header with measurements conducted on the common vent. Therefore, the actual number of leaking components and leak frequency are not known.

Table ES-4: Leaker emission factors for estimating fugitive emissions from Alberta UOG facilities on a volume^a or mass basis.

Sector	Component Type	Service	Leaker Count	Leaker EF (kg THC/h/source)	95% Confidence Limit (% of mean)		Leaker EF (sm ³ THC/h/source)	95% Confidence Limit (% of mean)	
					Lower	Upper		Lower	Upper
All	Compressor Rod-Packing ^b	PG	27	1.08150	45%	58%	0.77563	43%	56%
All	Connector	PG	145	0.13281	19%	21%	0.10137	20%	21%
All	Connector	LL	6	0.05906	71%	88%	0.04156	70%	85%
All	Control Valve	PG	16	0.16213	47%	50%	0.12203	48%	52%
All	Meter	PG	8	0.07201	39%	49%	0.05238	40%	50%
All	Open-Ended Line	PG	10	0.98904	90%	195%	0.70729	90%	199%
All	Pressure Relief Valve	PG	7	0.69700	49%	62%	0.50395	49%	63%
All	Pump Seal	PG	6	0.23659	71%	121%	0.16974	71%	125%
All	Regulator	PG	27	0.10275	45%	56%	0.09514	56%	79%
All	Thief Hatch	PG	6	0.81672	67%	83%	0.82401	75%	106%
All	Valve	PG	28	0.31644	58%	90%	0.24356	60%	97%
All	Valve	LL	6	0.23098	72%	107%	0.16929	71%	110%
All	SCVF	PG	15	2.70351	97%	201%	3.74007	97%	189%

^a Volumes are presented at standard reference conditions of 15°C and 101.325 kPa.

^b Because reciprocating compressor rod-packing leakage is routed to common vent lines, the actual number of leakers is not known. The compressor rod-packing ‘leaker’ factor is calculated on a per vent line basis (**not** per rod-packing basis). Rod-packings are defined as vents in Directive 060 (AER, 2018).

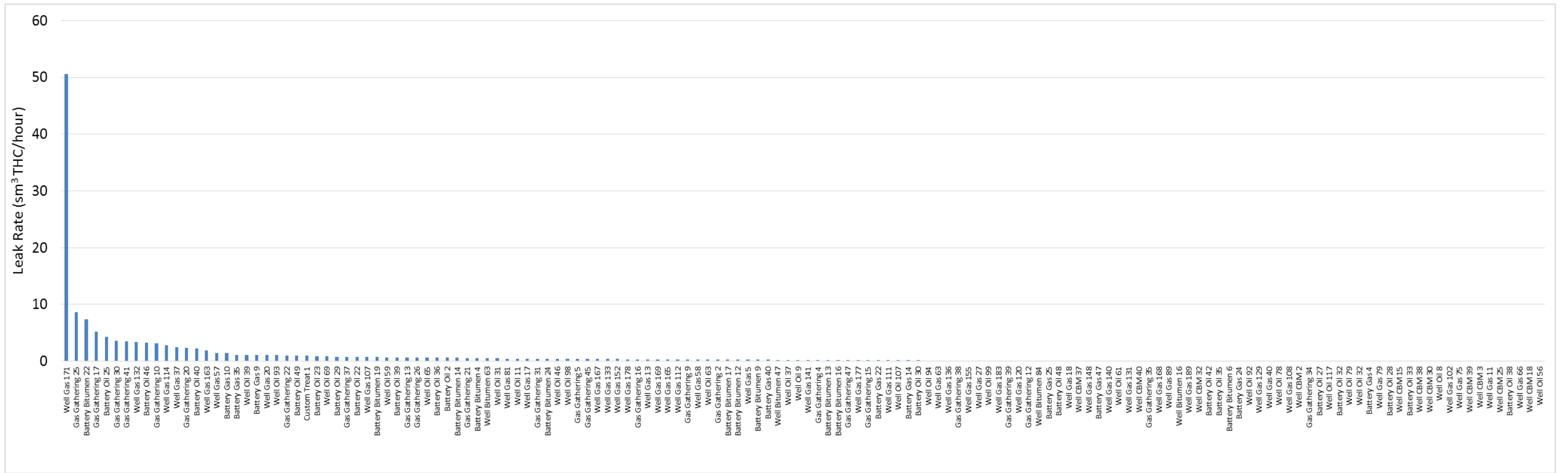

Figure ES-4: Distribution of total leak rate by site observed during the 2017 Alberta field campaign (excluding 195 sites where no leaks were detected).

SCVF Emission Factor

The SCVF component is included in Tables ES-3 and ES-4 to improve emission inventory transparency and highlight the significance of this source. The population average leak factor calculated from 15 leaks detected at the 440 wells screened in 2017 is 0.0925 kg THC per hour which is only 37 percent less than the factor used to estimate SCVF emissions in the last UOG national inventory (ECCC, 2014). SCVF was the second largest source of methane released by the UOG industry because of the very large number of potential leak sources (i.e., approximately 150,000 wells in Alberta). The refined emission factor and confidence interval decreases SCVF contributions to total methane emissions and uncertainty, however, it is expected to remain one of the top 5 methane emission contributors.

Components in Heavy Liquid Service

Also of note is that zero components in heavy liquid service were observed to be leaking. This is consistent with results presented in CAPP, 2014 and CAPP, 1992. Population average leak factors for components in heavy liquid service are presented in CAPP, 2005 but are at least one order of magnitude less than light liquid no-leak factors presented in Table 18. All four studies agree that components in heavy oil service have a very small contribution to total UOG fugitive emissions.

Comparison of Vent and Leak Emission Rates

In addition to the inventories and leak measurements discussed above, field inspectors recorded venting emission sources observed with the IR camera and estimated their release magnitude (or measured the release if convenient to do so with the High Flow Sampler). Moreover, pneumatic venting is estimated using the average emission factors. Although measurement of venting sources was not a primary objective for this study, available estimates for pneumatic and process vent sources enable a **qualitative** comparison with equipment leaks. Accordingly, the cumulative natural gas release rate is summed for all emission sources observed during the 2017 field campaign and presented by emission and source type in Figure ES-5. The largest contributors to equipment leaks are SCVF and reciprocating compressor rod-packings that represent approximately 60 percent of the total leak rate.

More importantly, the total leak rate is about 20 percent of the total natural gas released from all sources. Pneumatic devices (approximately 33 percent of the total release), production tanks (approximately 28 percent of the total release), heavy oil well casing vents (approximately 16 percent of the total release) and unlit flares (approximately 3 percent of the total release) are much more important sources natural gas emissions.

Although direct measurement of vent sources is often difficult to complete with the resources and equipment typically budgeted for leak surveys because of accessibility and process condition challenges (e.g., transient tank top emissions, dehydrator still columns or unlit flares).

Qualitative indicators obtained with an IR camera (e.g., the vent is small, large, or very large) may provide useful information to confirm production accounting completeness and improve the identification of cost-effective gas conservation or repair opportunities. This approach may identify venting sources where the release magnitude is not fully appreciated by operators and represents the small number of sources that contribute the majority of methane emissions. Although the IR Camera estimates are qualitative and not sufficient for production accounting purposes; they can identify process venting sources, provide an indication of abnormal behaviour and trigger root-cause analysis when images indicate a risk of exceeding regulated site venting limits.

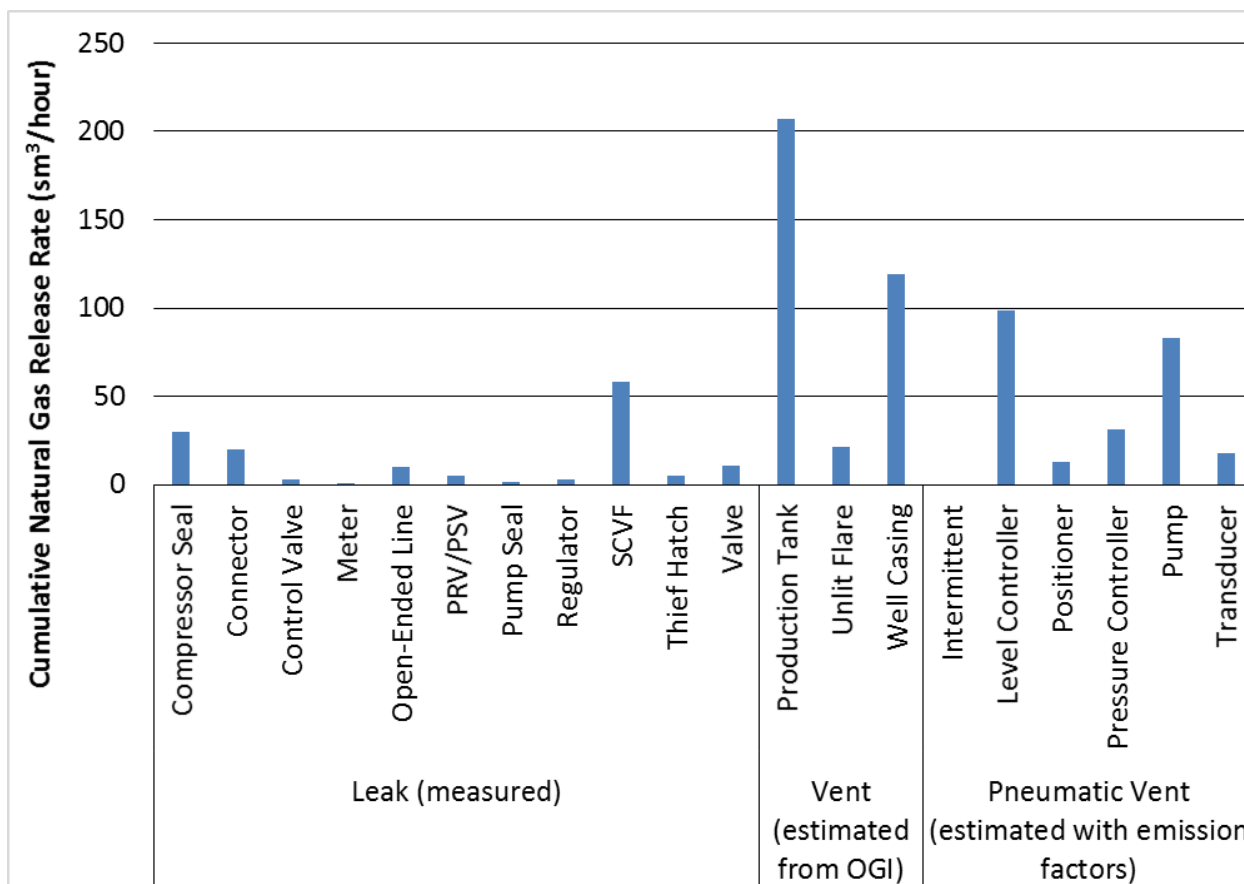

Figure ES-5: Cumulative hourly release rate for emission and source types observed at 333 locations during the 2017 Alberta field campaign.⁹

⁹ The venting estimates presented in Figure ES-5 have large, undetermined uncertainties and only provide a qualitative perspective on natural gas emission sources. Moreover, pneumatic results assume only half of the inventoried chemical pumps are active because many methanol injections pumps are only active during cold winter months. Also, in addition to flashing, breathing and working losses; production tank emissions may include contributions from well casing vents, leaks past liquid dump valves, unintentional gas flow-through from undersized separators.

TABLE OF CONTENTS

DISCLAIMER	i
EXECUTIVE SUMMARY	ii
TABLE OF CONTENTS	xix
LIST OF TABLES	xxii
LIST OF FIGURES	xxiv
LIST OF ACRYNOMS	xxvi
ACKNOWLEDGEMENTS	xxvii
1 INTRODUCTION	1
1.1 BACKGROUND	2
2 FIELD STUDY	5
2.1 Quality Assurance.....	7
2.2 Quality Control	8
2.3 Conversion of measured flow rates to THC mass rates.....	9
2.3.1 Conversion of Volumetric Flows from Meter to Standard Conditions.....	9
2.3.2 Conversion of Volumetric Flows to Mass Flows	10
2.3.3 Use of Response Factor	10
3 METHODOLOGY AND RESULTS	12
3.1 Process Equipment Counts	14
3.2 Component Counts.....	23
3.3 Emission Controls.....	36
3.4 Pneumatic Device Counts.....	37
3.5 Population Average Leak Factors.....	51
3.6 ‘Leaker’ Factors	54
3.7 Uncertainty Analysis.....	56
3.7.1 Component Counting Uncertainty	57
3.7.2 OGI Leak Detection Uncertainty	58
3.7.3 Bootstrapping Method	58
4 DISCUSSION	60
4.1 Process Equipment.....	60
4.1.1 Facilities	61
4.1.2 Wells	66
4.2 Components	68
4.3 Pneumatics	80
4.4 Population Average Leak Factors.....	82
4.4.1 Contribution of Fugitive Emissions Not Detected By The IR Camera	83
4.4.2 Distribution of 2017 Leaks and “super-Emitters”	84
4.4.3 Comparison of 2017 Results with Historic Fugitive Studies.....	84

4.4.4	Reciprocating Compressor Rod-Packing Leakage Rates Expected by Manufacturers	85
4.4.5	SCVF Emission Factor	86
4.4.6	Components in Heavy Liquid Service	86
4.5	Leaker Factor	89
4.6	Comparison of Vent and Leak Emission Rates	91
5	CONCLUSIONS AND RECOMMENDATIONS	93
5.1	Utilization of Factors	95
6	REFERENCES	96
7	APPENDIX – 2017 AER FIELD SAMPLING PLAN	99
7.1	Objective	99
7.2	Site Selection	99
7.2.1	Target Facilities	100
7.2.2	Target Wells.....	104
7.3	Data Collection Procedures (Using the Tablet)	105
7.3.1	Process Equipment and Component Counting	105
7.3.2	Pneumatic Device Counting	106
7.3.3	Fugitive and Vent Screening and Measurement	106
7.4	Training and QAQC.....	108
7.4.1	Class training	108
7.4.2	Field training.....	108
7.4.3	Data Collection Error Management	108
7.4.4	Data Completeness.....	109
7.5	Inspector Safety and Conduct.....	109
8	APPENDIX – STANDARDIZED DEFINITIONS.....	111
8.1	Emission Types.....	111
8.1.1	Leak.....	111
8.1.2	Vent.....	111
8.2	Service Types.....	112
8.2.1	Heavy Liquid	112
8.2.2	Light Liquid	112
8.2.3	Process Gas	112
8.3	Component Types	112
8.3.1	Reciprocating Compressor Rod-Packings	112
8.3.2	Centrifugal Compressor Seals.....	112
8.3.3	Connectors	113
8.3.4	Control Valve.....	113
8.3.5	Meters	113
8.3.6	Open-Ended Lines	113
8.3.7	Pressure-Relief Valve	113

8.3.8	Pump Seals.....	114
8.3.9	Regulators	114
8.3.10	Thief Hatch	114
8.3.11	Valves	114
8.3.12	Well Surface Casing Vent Flow (SCVF).....	114
8.4	Process Equipment Types	115
8.5	Technology Types.....	124
8.5.1	Leak Detection	124
8.5.1.1	Portable Catalytic/Thermal Conductivity Leak Detector.....	124
8.5.1.2	Portable Acoustical Leak Detector	125
8.5.1.3	Infrared Camera.....	125
8.5.2	Leak and Vent Measurement	126
8.5.2.1	Calibrated Bag.....	126
8.5.2.2	Full-flow Flow Meters.....	126
8.5.2.3	Hi-Flow Sampler.....	127
8.6	Facility SubType Codes	128
8.7	Well Status Codes	130
9	Appendix - Methodology For Assessing Uncertainties.....	133
9.1	Error Propagation Equations.....	133
9.1.1	Combining Uncertainties in Multiplication and Division Steps	134
9.1.2	Combining Uncertainties in Addition and subtraction Steps.....	134
9.2	Limitations to Rules of Combination of Uncertainties	135
9.3	Derivation of Error Propagation Equations	135
9.3.1	Uncertainty of multiplication and division	138
9.3.2	Uncertainty of Addition and Subtraction	139
9.3.3	Uncertainty of Combined Operations	139
10	Appendix - Leak Factors by Sector	141
11	Appendix - Raw Data (Blinded)	157

LIST OF TABLES

TABLE 1: ALBERTA ACTIVE FACILITY POPULATION (APRIL 2017) FOR SELECTED SUBTYPES AND FIELD SAMPLES SIZE.....	13
TABLE 2: ALBERTA ACTIVE WELL POPULATION (APRIL 2017) FOR SELECTED STATUS CODES AND FIELD SAMPLES SIZE.....	14
TABLE 3: AVERAGE (MEAN) PROCESS EQUIPMENT COUNTS AND CONFIDENCE INTERVALS PER FACILITY SUBTYPE.....	16
TABLE 4: AVERAGE (MEAN) PROCESS EQUIPMENT COUNTS AND CONFIDENCE INTERVALS PER WELL STATUS.....	20
TABLE 5: AVERAGE COMPONENT COUNTS (MEAN) AND CONFIDENCE INTERVALS PER PROCESS EQUIPMENT TYPE.....	25
TABLE 6: AVERAGE (MEAN) EMISSION CONTROL AND CONFIDENCE INTERVAL PER PROCESS EQUIPMENT UNIT.....	37
TABLE 7: AVERAGE (MEAN) PNEUMATIC DEVICE COUNTS AND CONFIDENCE INTERVALS PER FACILITY SUBTYPE.....	40
TABLE 8: AVERAGE (MEAN) PNEUMATIC DEVICE COUNTS AND CONFIDENCE INTERVALS PER WELL STATUS.....	43
TABLE 9: POPULATION AVERAGE EMISSION FACTORS FOR ESTIMATING FUGITIVE EMISSIONS FROM ALBERTA UOG FACILITIES ON A VOLUME OR MASS BASIS.....	53
TABLE 10: LEAKER EMISSION FACTORS FOR ESTIMATING FUGITIVE EMISSIONS FROM ALBERTA UOG FACILITIES ON A VOLUME OR MASS BASIS.....	55
TABLE 11: PARAMETER UNCERTAINTIES ACCORDING TO MEASUREMENT DEVICE OR GAS ANALYSIS SOURCE.....	56
TABLE 12: COMPARISON OF AVERAGE EQUIPMENT COUNTS PER FACILITY SUBTYPE FROM THE 2011 UOG NATIONAL INVENTORY (ECCC, 2014) VERSUS THOSE DERIVED FROM 2017 FIELD SURVEYS.....	63
TABLE 13: AVERAGE WELL PROCESS EQUIPMENT COUNTS OBSERVED IN 2017 VERSUS 2011 UOG INVENTORY COUNTS.....	67
TABLE 14: COMPARISON OF 2017 AVERAGE (MEAN) COMPONENT COUNTS TO VALUES HISTORICALLY USED FOR THE UOG NATIONAL EMISSION INVENTORY (CAPP, 1992).....	73
TABLE 15: DISTRIBUTION OF PNEUMATIC INSTRUMENT TYPES OBSERVED IN THE 2016/17 INVENTORY AND DEEPP DATABASE.....	80
TABLE 16: SAMPLE-SIZE WEIGHTED AVERAGE VENT RATES FOR PNEUMATIC DEVICE TYPES OBSERVED DURING 2016 AND 2017 FIELD CAMPAIGNS.....	82
TABLE 17: COMPARISON OF FUGITIVE EMISSIONS CALCULATED USING 2017, 2014 AND 2005 POPULATION AVERAGE LEAK FACTORS AND THE SAME COMPONENT POPULATION.....	85
TABLE 18: COMPARISON OF 2017 AND HISTORIC POPULATION AVERAGE LEAK FACTORS (KG THC/H/SOURCE) FOR THE CANADIAN UOG INDUSTRY.....	87
TABLE 19: LEAKER EMISSION FACTORS FOR ESTIMATING FUGITIVE EMISSIONS FROM CANADIAN UOG FACILITIES ON A VOLUME OR MASS BASIS.....	90
TABLE 20: PROCESS EQUIPMENT DESCRIPTIONS.....	115
TABLE 21: FACILITY SUBTYPES DEFINED IN AER MANUAL 011.....	128
TABLE 22: ARRANGEMENT OF DATA FOR ONE-WAY ANOVA TESTING. ^A	141
TABLE 23: RESULTS OF ANOVA.....	142
TABLE 24: PROCESS EQUIPMENT AND COMPONENT COUNT RECORDS FROM THE FIELD CAMPAIGN CONDUCTED AT ALBERTA UPSTREAM OIL AND NATURAL GAS (UOG) SITES FROM 14 AUGUST TO 23 SEPTEMBER 2017.....	157
TABLE 25: PNEUMATIC DEVICE COUNT RECORDS FROM THE FIELD CAMPAIGN CONDUCTED AT ALBERTA UPSTREAM OIL AND NATURAL GAS (UOG) SITES FROM 14 AUGUST TO 23 SEPTEMBER 2017.....	157

TABLE 26: LEAK AND VENT MEASUREMENT RECORDS FROM THE FIELD CAMPAIGN CONDUCTED AT ALBERTA
UPSTREAM OIL AND NATURAL GAS (UOG) SITES FROM 14 AUGUST TO 23 SEPTEMBER 2017.157

LIST OF FIGURES

FIGURE 1: 2011 ALBERTA UOG METHANE EMISSION CATEGORIES PRIORITIZED ACCORDING TO THEIR CONTRIBUTION TO TOTAL UNCERTAINTY (ECCC, 2014).	6
FIGURE 2: EXAMPLE OF TABLET DATA ENTRY FORM.	8
FIGURE 3: SURVEY LOCATIONS AND FACILITY SUBTYPES FOR THE 2017 MEASUREMENT CAMPAIGN.	12
FIGURE 4: PNEUMATIC COUNTS, BY DEVICE TYPE AND DRIVER TYPE, OBSERVED AT ALBERTA UOG FACILITIES AND WELLS DURING 2016 AND 2017 FIELD CAMPAIGNS.	38
FIGURE 5: DISTRIBUTION OF LEVEL CONTROLLER MODELS OBSERVED DURING 2016 AND 2017 SURVEYS.	46
FIGURE 6: DISTRIBUTION OF POSITIONER MODELS OBSERVED DURING 2016 AND 2017 SURVEYS.	46
FIGURE 7: DISTRIBUTION OF PRESSURE CONTROL MODELS OBSERVED DURING 2016 AND 2017 SURVEYS.	47
FIGURE 8: DISTRIBUTION OF TRANSDUCER MODELS OBSERVED DURING 2016 AND 2017 SURVEYS.	47
FIGURE 9: DISTRIBUTION OF CHEMICAL PUMP MODELS OBSERVED DURING 2016 AND 2017 SURVEYS.	48
FIGURE 10: PNEUMATIC COUNTS BY FACILITY SUBTYPE (EXCLUDING LOCATIONS WHERE ALL DEVICES ARE ASSIGNED TO WELLS) AND DRIVER TYPE.	49
FIGURE 11: PNEUMATIC COUNTS BY WELL STATUS CODE AND DRIVER TYPE.	50
FIGURE 12: THREE-PHASE VERTICAL SEPARATOR LOCATED AT A LIQUIDS-RICH GAS PRODUCTION SITE.	69
FIGURE 13: EXAMPLE OF A GAS REGULATOR INSTALLED ON AN OIL WELLHEAD.	70
FIGURE 14: COMPARISON OF 1992 AND 2017 TOTAL NUMBER OF COMPONENTS IN LIGHT LIQUID (LL) AND PROCESS GAS (PG) SERVICE FOR THE PROCESS EQUIPMENT PRESENTED IN TABLE 14 (COMPONENT COUNTS LESS THAN 50).	71
FIGURE 15: COMPARISON OF 1992 AND 2017 TOTAL NUMBER OF CONNECTORS AND VALVES IN LIGHT LIQUID (LL) AND PROCESS GAS (PG) SERVICE FOR THE PROCESS EQUIPMENT PRESENTED IN TABLE 14 (COMPONENT COUNTS GREATER THAN 50).	72
FIGURE 16: DISTRIBUTION OF PNEUMATIC INSTRUMENT TYPES OBSERVED DURING 2016 AND 2017 SURVEYS.	81
FIGURE 17: DISTRIBUTION OF CHEMICAL INJECTION PUMP TYPES OBSERVED DURING 2016 AND 2017 SURVEYS.	81
FIGURE 18: DISTRIBUTION OF TOTAL LEAK RATE BY SITE OBSERVED DURING THE 2017 ALBERTA FIELD CAMPAIGN (EXCLUDING 195 SITES WHERE NO LEAKS WERE DETECTED).	88
FIGURE 19: CUMULATIVE HOURLY RELEASE RATE FOR EMISSION AND SOURCE TYPES OBSERVED AT 333 LOCATIONS DURING THE 2017 ALBERTA FIELD CAMPAIGN.	92
FIGURE 20: EXAMPLE OF TARGET AND NON-TARGET FACILITY IDs FOR A SINGLE LOCATION.	101
FIGURE 21: EXAMPLE MEASUREMENT SCHEMATIC WITH TARGET AND NON-TARGET FACILITY IDs.	102
FIGURE 22: EXAMPLE MEASUREMENT SCHEMATIC WITH INCORRECT FACILITY ID LOCATIONS LISTED IN PETRINEX (EQUIPMENT IS NOT SURVEYED).	103
FIGURE 23: EXAMPLE OF WELLS (UWI) THAT REPORT (FLOW) TO PETRINEX FACILITY ID.	105
FIGURE 24: NUMBER OF UWIs (REPRESENTING PRODUCTION STRINGS) AND WELL LICENCES (REPRESENTING WELLHEADS WITH HYDROCARBON FLOWS) FOR EACH WELL STATUS CODE REPORTED IN PETRINEX FOR DECEMBER 2017.	131
FIGURE 25: POPULATION-AVERAGE LEAK RATES FOR ROD-PACKINGS IN PROCESS GAS SERVICE BY SECTOR.	143
FIGURE 26: POPULATION-AVERAGE LEAK RATES FOR CONNECTORS IN PROCESS GAS SERVICE BY SECTOR.	144
FIGURE 27: POPULATION-AVERAGE LEAK RATES FOR CONNECTORS IN LIGHT LIQUID SERVICE BY SECTOR.	145
FIGURE 28: POPULATION-AVERAGE LEAK RATES FOR CONTROL VALVES IN PROCESS GAS SERVICE BY SECTOR.	146
FIGURE 29: POPULATION-AVERAGE LEAK RATES FOR METERS IN PROCESS GAS SERVICE BY SECTOR.	147

FIGURE 30: POPULATION-AVERAGE LEAK RATES FOR OPEN-ENDED LINES IN PROCESS GAS SERVICE BY SECTOR.	148
FIGURE 31: POPULATION-AVERAGE LEAK RATES FOR PRV/PSVs IN PROCESS GAS SERVICE BY SECTOR.....	149
FIGURE 32: POPULATION-AVERAGE LEAK RATES FOR PUMP SEAL IN PROCESS GAS SERVICE BY SECTOR.	150
FIGURE 33: POPULATION-AVERAGE LEAK RATES FOR REGULATORS IN PROCESS GAS SERVICE BY SECTOR...	151
FIGURE 34: POPULATION-AVERAGE LEAK RATES FOR SCVFs IN PROCESS GAS SERVICE BY SECTOR.....	152
FIGURE 35: POPULATION-AVERAGE LEAK RATES FOR THIEF HATCHES IN PROCESS GAS SERVICE BY SECTOR.	153
FIGURE 36: POPULATION-AVERAGE LEAK RATES FOR VALVES IN PROCESS GAS SERVICE BY SECTOR.	154
FIGURE 37: POPULATION-AVERAGE LEAK RATES FOR VALVES IN LIGHT LIQUID SERVICE BY SECTOR.....	155

LIST OF ACRYNOMS

AEP	Alberta Environment and Parks
AER	Alberta Energy Regulator
BMP	Best Management Practices
C	Component
CAPP	Canadian Association of Petroleum Producers
CEL	Clearstone Engineering Ltd.
DI&M	Direct Inspection and Maintenance
ECON	Saskatchewan Ministry of Economics
EF	Emission Factor
FG	Fuel Gas
GHG	Greenhouse gas
GM	Gas Migration
GV	Gas/Vapour (process and sales gas)
h	Hour
HL	Heavy Liquid
IPCC	Intergovernmental Panel on Climate Change
IR	Infrared (camera)
kg	Kilogram
LDAR	Leak Detection and Repair
LF	Leak Frequency
LL	Light Liquid
MDL	Minimum Detection Limit
N	Number of components
NIR	National Inventory Report
OGC	British Columbia Oil and Gas Commission
OGI	Optical Gas Imaging
QA	Quality Assurance
QC	Quality Control
SR	Sour
SW	Sweet
THC	Total Hydrocarbon
UNFCCC	United Nations Framework Convention on Climate Change
UOG	Upstream Oil and Gas
US EPA	United States Environmental Protection Agency
VOC	Volatile Organic Compound
VRU	Vapour Recovery Unit

ACKNOWLEDGEMENTS

The development of this report was sponsored by the Natural Resources Canada Energy Innovation Program and supported by the Alberta Energy Regulator. The support and direction provided by each of the participating agencies and companies listed below is gratefully acknowledged. Special thanks are given to the individuals and companies who hosted field surveys and/or provided review comments.

- Alberta Energy Regulator – Climate Policy Assurance Team
- Carleton University
- Greenpath Energy Ltd.

1 INTRODUCTION

A field study was conducted during the period of 14 August to 23 September 2017 to inventory equipment and components in hydrocarbon service as well as measure detected leaks. The study was completed under the authority of the Alberta Energy Regulator (AER) and funded by Natural Resources Canada (NRCan) with the objective of improving confidence in methane emissions from Alberta upstream oil and natural gas (UOG) fugitive equipment leaks, pneumatic devices and reciprocating rod-packings.

This report describes the field campaign and methodology applied to determine average factors and confidence intervals for the following parameters. These results are intended for an emission inventory model used to predict equipment/component counts, uncertainties and air emissions associated with UOG facility and well identifiers.

- Process equipment count per facility subtype¹⁰ or well status code¹¹.
- Component count per process equipment unit¹².
- Emission control type (i.e., gas conservation or gas tied into flare) per process equipment unit.
- Pneumatic device count per facility subtype or well status code by device (e.g., level controllers, positioners, pressure controllers, transducers, chemical pumps and intermittent) and driver (e.g., natural gas, instrument air, propane or electricity) types.
- Leak rate per component and service type¹³ considering the entire population of components with the potential to leak (i.e., ‘population average’ factor).
- Leak rate per component and service type considering leaking components only (i.e., ‘leaker’ factor).

Fugitive equipment leaks and pneumatic venting sources are targeted by this study because they contribute approximately 17 and 23 percent, respectively, of methane emissions in the 2011 national inventory (ECCC, 2014) and are based on uncertain assumptions regarding the population of UOG equipment and components. Moreover, a 2014 leak factor update report published by the Canadian Association of Petroleum Producers (CAPP) recommended equipment and component counts be refined based on field inventories and standardized definitions because of limitations encountered when determining these from measurement schematics, process flow diagrams (PFD) or piping and instrumentation diagrams (P&ID) (CAPP, 2014 sections 4.1.1 and 4.2.1).

10 Facility subtypes are defined in Table 2 of [AER Manual 011](#) (AER, 2016b).

11 Well status codes are defined by the four category types (fluid, mode, type and structure) that describe wells listed on the [AER ST37 report](#).

12 Process equipment units are defined in Appendix Section 8.4.

13 Component types and service types are defined in Appendix Sections 8.2 and 8.3.

The scope of this study targets UOG wells, multi-well batteries, and compressor stations belonging to AER facility subtypes listed in Section 3. Larger UOG facilities and oil sands operations are specifically excluded from this study because they are often subject to regulated emission quantification, verification and compliance requirements that motivate accurate, complete and consistent methane emission reporting.

Details of the field study and selection criteria of survey locations as well as quality assurance (QA) and quality control (QC) measures are presented in Sections 2 and 7. The data and uncertainty analysis methodology and results are provided in Section 3. A discussion and comparison of results to other studies are presented in Section 4. The key conclusions and recommendations of this study are given in Section 5. All references cited herein are listed in Section 6. Standard definitions for terms used throughout this document are presented in Appendix Section 8 while blinded raw data from the field campaign is available in Appendix Section 11.

1.1 BACKGROUND

Fugitive equipment leaks are defined in Section 8.1.1 as an unintentional loss of process fluid, past a seal, mechanical connection or minor flaw, that can be visualized with an infrared (IR) leak imaging camera (herein referred to as optical gas imaging (OGI) method) or detected by an organic vapour analyzer (with a hydrocarbon concentration screening value greater than 10,000 ppmv) in accordance with U.S. EPA Method 21. An EPA comparison of OGI versus Method 21 based leak factors observed that leaker emission factors determined from more recent OGI study data agreed reasonably well with the leaker emission factors developed from Method 21-based data with a leak screening threshold of 10,000 ppmv (US EPA, 2016). The study also observed that leaker emission factors determined using Method 21 (and a leak threshold of 500 ppmv) are statistically different than OGI-based leaker emission factors. This suggests the OGI method is reasonably equivalent to Method 21 for detecting leaks with a screening concentration greater than 10,000 ppmv but not appropriate for use where the desired screening concentration is 500 ppmv.

Emissions from fugitive equipment leaks and pneumatic venting are most often estimated for use in emissions inventories by multiplying component populations by corresponding average emission factors. Emission estimates based on these factors are used by companies for regulatory reporting and by governments to meet national and international reporting agreements.

For the Canadian upstream oil and natural gas (UOG) industry, the most up-to-date set of average fugitive factors are published in CAPP, 2014 and intended to reflect best management practices (BMP) for the management of fugitive emissions (CAPP, 2007). However, the 2014 assessment encountered challenges determining equipment and component counts that impacted the accuracy of emission factor results. The 2017 field work is largely driven by

recommendations from CAPP, 2014 and extended to include pneumatic inventories (that are subject to similar challenges).

- Process equipment and corresponding component count schedules be developed from a dedicated field inventory campaign.
- The field campaign should establish and utilize standardized definitions for major equipment, component, service and emission types.

Notwithstanding these limitations, engineering judgement was applied to bridge data gaps when sufficient supporting data was available and the resulting emission factors recommended for use for facilities subject to the CAPP BMP.

The BMP identifies key sources UOG fugitive emissions and strategies for achieving cost-effective reductions through the implementation of a Directed Inspection & Maintenance (DI&M) program. The DI&M program enables flexibility regarding target components, screening frequency, measurement and repair through a prioritized decision tree that considers criteria such as health, safety, and environment impact; repair difficulty; repair economics; and the requirement for a facility shutdown.

The CAPP BMP was promulgated through the following regulatory instruments but remains a voluntary initiative for Saskatchewan and other provinces. The BMP succeeded in greater awareness, improved management and has a downward influence on UOG fugitive emissions. However, uncertainty persists regarding the magnitude and most effective approach to managing fugitive emissions.

- Alberta Energy Regulator (AER) Directive 060: Upstream Petroleum Industry Flaring, Incinerating, and Venting.
- British Columbia Oil and Gas Commission (OGC) Flaring and Venting Reduction Guideline.

Earlier emission factors were based on emissions data collected over the mid-1990s to the early 2000s and published as part of the CAPP/Environment Canada/NRCAN Upstream Oil and Gas emission inventory (CAPP, 2005). They reflect the level of control inherent with the operating and regulatory environment in Canada from the early 1990's until formal leak management programs were implemented in 2007. This environment may be characterized as one in which safety inspections, routine visual inspections, area monitoring and regular facility turn-arounds are conducted. However, there were no specific programs to detect leaks on a regular basis using a portable organic analyzer, and there were no policies for immediate repair of these leaks.

In general, the studies referenced above indicate fugitive emissions from equipment leaks are due to normal wear and tear, improper or incomplete assembly of components, inadequate material specification, manufacturing defects, damage during installation or use, corrosion, fouling and

environmental effects (e.g., vibrations and thermal cycling). The potential for such emissions depends on a variety of factors including the type, style and quality of components, type of service (gas/vapour, light liquid or heavy liquid), age of component, frequency of use, maintenance history, process demands, whether the process fluid is highly toxic or malodorous and operating practices.

Most of the atmospheric emissions from fugitive equipment leaks tend to be from components in natural gas or hydrocarbon vapour service rather than from those in hydrocarbon liquid service¹⁴. Components in odourized or H₂S service tend to have much lower average fugitive emissions than those in non-odourized or non-toxic service. Components tend to have greater average emissions when subjected to frequent thermal cycling, vibrations or cryogenic service. Different types of components have different leak potentials and repair lives.

¹⁴ This reflects the greater difficulty in containing a gas than a liquid (i.e., due to the greater mobility or fluidity of gases), and the general reduced visual indications of gas leaks.

2 FIELD STUDY

The field equipment inventory and measurement campaign was completed in August and September of 2017. The field sampling plan is presented in Section 7 and followed the fugitive emission measurement protocol recommended by the Canadian Energy Partnership for Environmental Innovation (CEPEI, 2006) with the OGI method used for leak detection. The field campaign targeted sites belonging to facility subtypes that contribute the most to uncertainty in the Alberta UOG methane emission inventory. Survey locations were randomly selected from the facility subtype populations belonging to the following UOG industry segments.

- Natural Gas Production (includes subtypes 351, 361, 362, 363, 364, 365, 366, 367, 601, 621, and 622)
- Light and Crude Oil Production (includes subtypes 311, 321 and 322)
- Cold Heavy Crude Oil Production (includes subtypes 331, 341, 342 and 611)

Location selection was further constrained by:

- Exclusion of sites that emit more than 100,000 t CO₂E because these sites are already subject to SGER GHG reporting and verified by independent 3rd party.
- Proximity to urban centers where target facility clustering was observed (i.e., central logistical nodes were selected for field team accommodation). Sites within 100 km radius of the following cities were visited: Brooks, Calgary, Red Deer, Drayton Valley, Grand Prairie and Bonnyville.
- Time budgeted to complete surveys within a geographical area.
- Logistical challenges encountered by field teams upon arrival (e.g., access restrictions due to standing crops or poor road conditions).

Facility subtypes contributing the most to methane uncertainty were identified as part of a decision framework that identified risks to achieving ISO GHG emission inventory principles of accuracy, transparency, completeness, relevance and consistency (Clearstone, 2017). The outcome of this process is the Figure 1 matrix that ranks emission subcategories according to their contribution to total uncertainty in Alberta's 2011 UOG methane emission inventory (ECCC, 2014) and presents qualitative indicators of methane emission contributions¹⁵.

The QA/QC activities completed to ensure the reliability of field data are described in Sections 2.1 and 2.2. Calculations required to convert leak rates, measured at local conditions by three different methods, to total hydrocarbon (THC) mass rates are described in Section 2.3.

¹⁵ Indicators are presented for each intersect where “High” is greater than 1 percent of total methane, “Low” is greater than 0.01 percent, but less than 1 percent of total methane, and ‘Negligible’ is less than 0.01 percent of total methane (and the sum of all “Negligible” intersects is less than 1 percent of total methane).

Emission SubCategory Description	Well Drilling, Servicing and Testing	Natural Gas Processing	Natural Gas Production	Natural Gas Transmission and Distribution	Light and Medium Crude Oil Production	Thermal Heavy Crude Oil Production	Cold Heavy Crude Oil Production	Disposal and Waste Treatment	Accidents and Equipment Failures
Accidental well SCVF & GM	Negligible	Negligible	Negligible	Negligible	Negligible	Negligible	Negligible	Negligible	High
Petrinex venting	Low	Low	High	Low	High	Low	High	Negligible	Negligible
Fugitive equipment leaks	Negligible	Low	High	High	High	Low	High	Negligible	Negligible
Pneumatic devices	Low	Low	High	Low	High	Low	High	Negligible	Negligible
Storage Losses	Negligible	Low	Low	Negligible	Low	Low	High	Negligible	Negligible
Accidental ruptures	Negligible	Negligible	Negligible	Negligible	Negligible	Negligible	Negligible	Negligible	Low
Natural gas fuel combustion	Negligible	High	High	Low	Low	Low	Low	Negligible	Negligible
Dehydrator Off-Gas	Negligible	Low	High	Negligible	Low	Negligible	Negligible	Negligible	Negligible
Compressor starts	Negligible	Low	High	Negligible	Low	Low	Low	Negligible	Negligible
Flaring	Low	Low	Low	Negligible	Low	Low	Low	Low	Negligible
Compressor rod-packings	Negligible	Low	Low	Negligible	Low	Negligible	Low	Negligible	Negligible
Loading losses (Crude Oil)	Negligible	Negligible	Low	Negligible	Low	Negligible	Low	Negligible	Negligible
Loading losses (NGLs)	Negligible	Low	Negligible	Negligible	Negligible	Negligible	Negligible	Negligible	Negligible

Figure 1: 2011 Alberta UOG methane emission categories prioritized according to their contribution to total uncertainty (ECCC, 2014).

2.1 QUALITY ASSURANCE

A data collection and management system was implemented to ensure reliability of sample data. This includes the following quality assurance (QA) measures:

- Selected field technicians are knowledgeable of the subject matter and trained to complete project data collection tasks. Greenpath Energy Ltd. (Greenpath) was subcontracted to lead field surveys. Greenpath technicians were paired with an AER inspector or a Clearstone engineer to enhance field team depth with respect to regulatory inspections and process knowledge. Selected field team members were knowledgeable of potential fugitive emission sources at UOG facilities and attended three days of desktop and field training dedicated to implementing the field sampling plan described in Section 7. Team members were responsible for understanding equipment, component, service and emission type definitions in Section 8 as well as applying standardized data collection and measurement methods described in Section 7 as part of the project quality management plan.
- Appropriate leak detection and measurement equipment for the site conditions and source characteristics encountered at UOG facilities. The equipment is regularly serviced and maintained in accordance with the manufacturer's specifications, and subjected to regular calibration and functional checks.
- Field observations were documented in a complete and consistent manner using a software application designed for this project. The application was installed on field tablets and pre-populated with site identifiers (e.g., Petrinex Facility IDs and UWIs) and standard definitions (Section 8). Field technicians selected applicable records from drop-down menus as presented in Figure 2. Record typing was limited to observed leak rates, component counts and comments.
- Photos were taken of each site placard to confirm the surveyed location is the same as the selected location appearing in the final dataset. Photos were taken of each equipment unit to confirm the correct equipment type was selected and reasonable component counts were completed. Infrared (IR) camera videos were recorded to confirm the component type and leak magnitude.

Surface Location	01-04-041-02W5	Facility Inspection Date	Dec 31, 1969	PICK DATE
Unique Well Identifier	1000010404102W500	As Found Emission Rate (cfm)	0.0	
Petrinex Facility ID	ABBT0085759	Location Notes	Test location notes	
Equipment Type	Catalytic Heater	Emission Type	Leak	
Service Type	Process Gas	Location Notes	Test location notes	
Component Main Type	Compressor Seal			

Figure 2: Example of tablet data entry form.

- Tablet data was uploaded to an online repository at the end of each working day to minimize data loss risk (e.g., due to damaged or lost tablets). Backup files were archived on the tablet and available at the end of the field campaign to confirm no data leakage occurred.
- A routine was developed to automate parsing of tablet records into an SQL database to minimize processing time and transcription errors. The use of a database application enables complex information retrievals and custom analysis of information that simply would not be practicable with a spreadsheet. The SQL database manages information in precisely defined tables for:
 - Equipment counts, component counts and emission controls,
 - Pneumatic counts and drivers, and
 - Leak and vent measurements.

2.2 QUALITY CONTROL

The following quality control (QC) procedures tested sample data against sample plan specifications.

- To identify and mitigate data collection errors, records are reviewed by the field team coordinator on a daily basis. When observed, problematic records were corrected and communicated to the entire field team to prevent future occurrences.
- The possibility of data leakage between the field tablets and final SQL database was checked by comparing tablet archives to final database records.

- Site placard photos, equipment photos, IR videos and measurement schematics are used during post survey processing to determine the validity of data outliers. For data entry error cases, reasonable corrections were made based on available images. The availability of inspection images and corporate schematics is of tremendous benefit when conducting QC tests on raw data records.
- Various post-processing statistical tests and quality control checks were performed on the data to ensure records are correctly classified and representative of process conditions. For example, the population of tank ‘thief hatch’ components was reviewed to ensure they were only counted when in pressurized hydrocarbon service (i.e., thief hatches are only counted for tanks tied into a VRU or flare). If not tied into a VRU or flare, atmospheric tank vapours released from a goose neck vent or open thief hatch are intentional and defined as a vent.
- Raw data records were provided to the operator of each site surveyed. Written feedback regarding data corrections were received from five operators and mostly related to assignment of process equipment to Facility IDs. When merited, refinements were made to the dataset.

2.3 CONVERSION OF MEASURED FLOW RATES TO THC MASS RATES

The steps required to convert measured flow rate to THC mass rates are delineated in the following subsections.

2.3.1 CONVERSION OF VOLUMETRIC FLOWS FROM METER TO STANDARD CONDITIONS

Metered volumetric flows are converted from the actual conditions of the meter to standard reference conditions of 15°C and 101.325 kPa using the following relation:

$$Q_{STP} = c \cdot x_{THC} \cdot Q_M \frac{P_M(T_S + 273.15)}{P_S(T_M + 273.15)}$$

Equation 1

Where,

- Q_{STP} = measured THC volumetric flow rate referenced at standard temperature and pressure (m³ THC/h),
- Q_M = measured volumetric flow rate referenced at the actual temperature and pressure of the flow meter (ft³/min),
- P_M = absolute reference pressure of the flow meter (kPa),

P_S	= standard pressure (i.e., 101.325 kPa),
T_S	= standard temperature (i.e., 15 °C),
T_M	= reference temperature of the flow meter (°C),
x_{THC}	= THC mole fraction applied only when Q_M is a whole gas flow (measured with the Hawk meter or calibrated bag). Not applied for Hi-Flow measurements.
c	= conversion factor = 1.699 m ³ ·h ⁻¹ ·ft ³ ·min.

2.3.2 CONVERSION OF VOLUMETRIC FLOWS TO MASS FLOWS

The volumetric flow rate is converted to a mass flow rate using the following relation:

$$\dot{m} = Q_{STP} \frac{P \cdot MW_{THC}}{R(T + 273.15)}$$

Equation 2

Where,

\dot{m}	= mass flow rate (kg THC/h),
Q_{STP}	= THC volumetric flow rate at standard reference conditions (m ³ THC/h),
P	= absolute pressure (kPa) at the reference conditions of the flow.
T	= temperature (°C) at the reference conditions of the flow.
MW_{THC}	= Molecular weight of hydrocarbon compounds
R	= gas constant = 8.3145 kPa·m ³ ·kmole ⁻¹ ·K ⁻¹ .

2.3.3 USE OF RESPONSE FACTOR

Most gas detectors are able to detect more than one type of compound but have different sensitivities to each. Gas detectors calibrated to methane are adequate for the purposes of screening components in natural gas service; however, the results of emission measurement methods that use gas detectors (e.g., the Hi-Flow Sampler) require corrections to more accurately account for the non-methane constituents of the natural gas mixture. This may be done using response factors. The response factor for a specific substance i may be defined by the relation:

$$RF_i = \frac{\text{Actual Concentration}}{\text{Instrument Reading}}$$

Equation 3

Substance specific response factors for the catalytic oxidation sensor installed in the Hi-Flow Sampler used in this study are obtained from Table D-1 of EPA, 1995. The response factor for gas mixtures observed during the study are estimated using the relation:

$$RF_M = \frac{1}{\sum_{i=1}^N \frac{Y_i}{RF_i}}$$

Equation 4

Where,

RF_M = estimated response factor of the mixture,
 Y_i = mole fraction of component i (kmol of component i/kmol of gas or vapour),
 N = number of components in the mixture.

The determined value of RF_M is then applied using Equation 5 to adjust measured emission rates.

$$Q = Q_m \cdot RF_M$$

Equation 5

Where,

Q_m = the uncorrected volumetric emission rate determined by the applied measurement technique.

3 METHODOLOGY AND RESULTS

Data collection and leak surveys were completed at 333 locations, operated by 63 different companies, and included 241 production accounting reporting entities and 440 UWIs. This sample data represents the vintage, production characteristics and regulatory oversight corresponding to UOG facilities operating in Alberta during 2017. The number of sites surveyed and total site populations are delineated by target facility subtype in Table 1 and well status code in Table 2. The geographic distribution of survey locations is illustrated in Figure 3 while blinded raw data from the field campaign is available in Appendix Section 11.

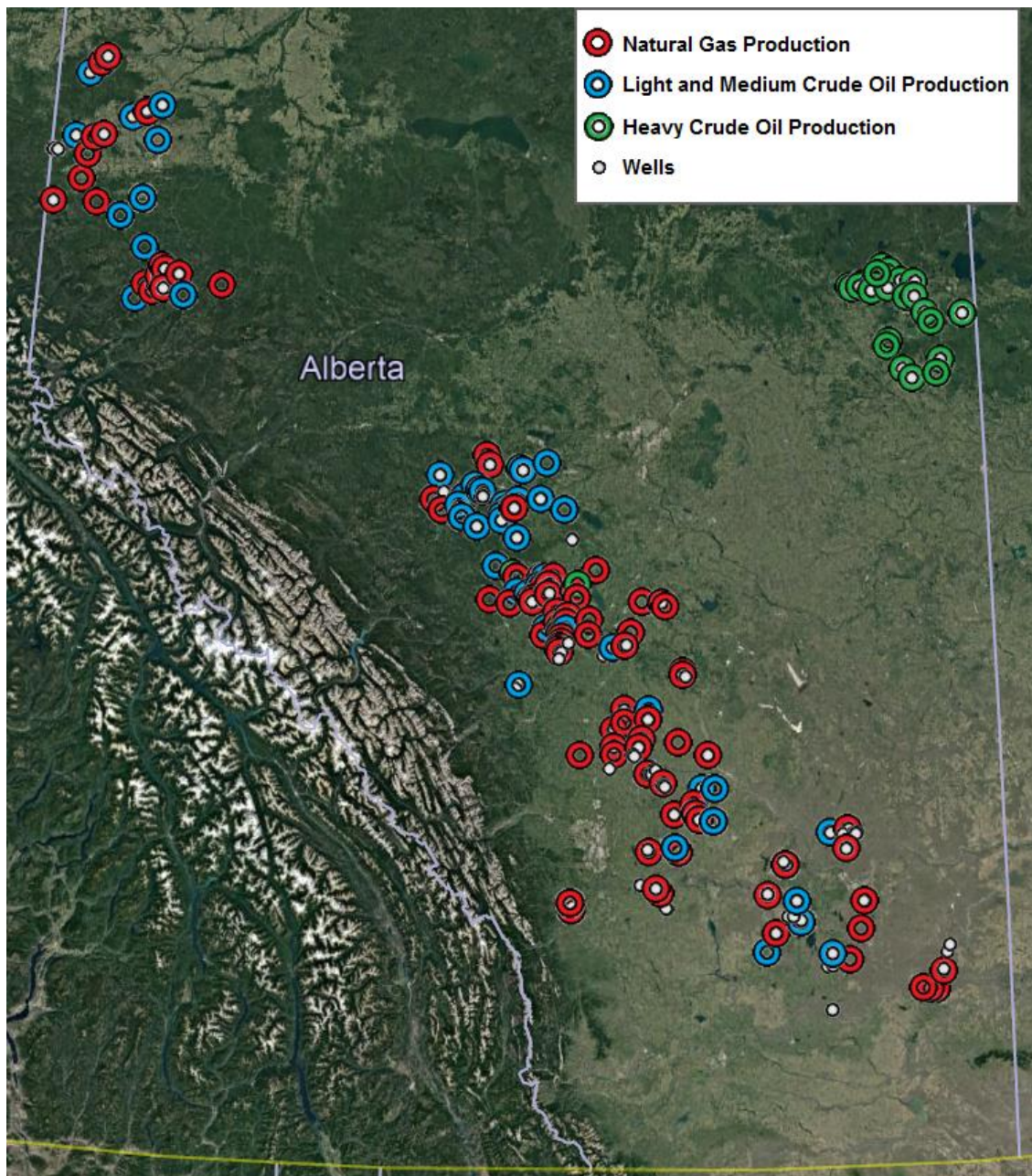

Figure 3: Survey locations and facility subtypes for the 2017 measurement campaign.

Standardized data collection methods and strict definitions for component, equipment, service, emission and facility type are documented in the sampling plan and used by field teams. Field observations and measurements for a location are assigned to corresponding Petrinex¹⁶ facility identifiers (ID) and UWI based on measurement schematics provided by subject operators (as described in Section 7.2). Field observations are correlated to Facility IDs and UWIs so that the resulting factors are representative and applicable to the AER regulated UOG industry managed by Petrinex data models.

Table 1: Alberta active facility population (April 2017) for selected subtypes and field samples size.

Subtype Code	Subtype Description	Total Population	Sample Size
351	Gas Single	4226	20
361	Gas Multiwell Group	2548	28
362	Gas Multiwell effluent	355	12
311	Crude Oil (Medium) Single	4263	23
321	Crude Oil (Medium) Multiwell Group	368	10
322	Crude Oil Multiwell Proration	1720	33
331	Crude bitumen single-well	861	5
341	Crude bitumen multiwell group	1263	12
342	Crude bitumen multiwell proration	342	13
363	Gas Multiwell proration SE AB	412	11
364	Gas Multiwell proration outside SE AB	691	20
601	Compressor Station	760	16
611	Custom Treating Facility	41	4
621	Gas Gathering System	2573	34
Total		20423	241

Field teams were instructed to obtain a complete inventory of equipment represented by subject Petrinex Facility IDs and survey at least five wells belonging to each multi-well battery visited. In some cases, all wells are located on the same lease location but in other cases, wells are at multiple off-site locations. Equipment dedicated to the well (e.g., a wellhead) is assigned to the subject UWI whereas equipment servicing multiple wells (e.g., a booster compressor) is assigned to the Facility ID.

¹⁶ Petrinex is a joint strategic organization supporting Canada's upstream, midstream and downstream petroleum industry. It delivers efficient, standardized, safe and accurate management of "data of record" information essential to the operation of the petroleum sector.

Table 2: Alberta active well population (April 2017) for selected status codes and field samples size.

Well Status Code	Description	Total Population	Sample Size
CBMCLS Flow	Coalbed Methane Flowing Well – Coals Only	6630	14
CBMOT Flow	Coalbed Methane Flowing Well – Coals & Other Lithology	14361	21
CBMOT Pump	Coalbed Methane Well (equipped with a plunger lift) – Coals & Other Lithology	46	1
CR-BIT ABZONE	Crude Bitumen Well – Abandoned Zone	14	1
CR-BIT Pump	Crude Bitumen Pumping Well	6630	85
CR-BIT Susp	Crude Bitumen Well – Suspended	3	2
CR-OIL Flow	Crude Oil Flowing Well	2807	21
CR-OIL PUMP	Crude Oil Pumping Well	27856	103
GAS FLOW	Natural Gas Flowing Well	74838	127
GAS PUMP	Natural Gas Well (equipped with a plunger lift)	14827	62
GAS STORG	Natural Gas Storage Well	139	2
SHG Flow	Shale Gas Flowing Well	284	1
Total		148435	440

Gas analysis were requested from operators for sites with noteworthy equipment leaks¹⁷. When site-specific analysis are not available, a typical gas composition is used to calculate mass emission rates (Table 26 in Volume 3 of ECCO, 2014).

Methodologies applied to calculate factors and the results are delineated in subsequent sections. All volumes are presented on a dry basis at standard reference conditions 101.325 kPa and 15° C. The uncertainty analysis and determination of confidence intervals is presented in Section 3.7.

3.1 PROCESS EQUIPMENT COUNTS

Process equipment in pressurized hydrocarbon service were counted for each location surveyed. The counts included both operating and pressurized non-operating equipment selected from the list of 54 predefined process equipment types delineated in Section 8.4. Units that didn't appear to match predefined types were entered as 'other' and added to a new or existing equipment type, during post-processing, based on a photo of the unit and facility measurement schematic. Process equipment and components entirely in water, air¹⁸, lubricating oil and non-volatile chemical service were **not** included in the inventory because they are less likely to emit hydrocarbons.

¹⁷ Laboratory analysis reports were requested for the top 20% of leakers for each component and service type.

¹⁸ Pneumatic devices driven by instrument air were inventoried as discussed in Section 3.4. The air compressor and piping were not inventoried.

The average (mean) process equipment count for a given facility subtype or well status is determined using the following relation:

$$\bar{N}_{PE} = \frac{N_{PE}}{N_{F/W}}$$

Equation 6

Where,

\bar{N}_{PE} = average (mean) process equipment count for a given facility subtype or well status,

N_{PE} = total number of process equipment surveyed for a given facility subtype or well status,

$N_{F/W}$ = total number of facilities or wells surveyed for the subject facility subtype or well status.

Average process equipment counts and confidence intervals per facility subtype and well status are presented in Table 3 and Table 4 respectively.

Table 3: Average (mean) process equipment counts and confidence intervals per facility subtype.

Facility SubType Code	Process Equipment Type	Facility SubType Count	Process Equipment Count	Average Equipment Count	95% Confidence Limit (% of mean)	
					lower	upper
321	Catalytic Heater	10	13	1.296	77%	85%
321	Flare KnockOut Drum	10	2	0.200	100%	149%
321	Gas Boot	10	1	0.100	100%	201%
321	Gas Pipeline Header	10	1	0.101	100%	197%
321	Incinerator	10	1	0.099	100%	204%
321	Line Heater	10	4	0.397	100%	102%
321	Liquid Pipeline Header	10	1	0.101	100%	197%
321	Pig Trap (Gas Service)	10	2	0.199	100%	151%
321	Pop Tank	10	1	0.101	100%	198%
321	Production Tank (fixed roof)	10	13	1.302	54%	77%
321	Screw Compressor	10	1	0.101	100%	198%
321	Separator	10	7	0.703	72%	85%
322	Catalytic Heater	33	136	4.125	35%	44%
322	Flare KnockOut Drum	33	10	0.303	50%	50%
322	Gas Boot	33	2	0.060	100%	151%
322	Gas Pipeline Header	33	7	0.212	57%	71%
322	Gas Sample and Analysis System	33	2	0.061	100%	199%
322	Gas Sweetening: Amine	33	1	0.031	100%	197%
322	Line Heater	33	6	0.181	67%	100%
322	Liquid Pipeline Header	33	31	0.942	32%	38%
322	Liquid Pump	33	10	0.304	80%	109%
322	Pig Trap (Gas Service)	33	9	0.273	67%	77%
322	Pig Trap (Liquid Service)	33	14	0.424	57%	72%
322	Pop Tank	33	7	0.211	71%	87%
322	Power Generator (natural gas fired)	33	1	0.031	100%	197%
322	Production Tank (fixed roof)	33	85	2.580	28%	32%
322	Propane Fuel Tank	33	2	0.061	100%	149%
322	Reciprocating Compressor	33	7	0.212	100%	143%
322	Reciprocating Compressor - Electric Driver	33	3	0.091	100%	100%
322	Screw Compressor	33	5	0.151	100%	181%
322	Screw Compressor - Electric Driver	33	3	0.091	100%	167%
322	Scrubber	33	1	0.030	100%	201%
322	Separator	33	81	2.452	30%	30%
322	Tank Heater	33	1	0.030	100%	202%
322	Treater	33	20	0.607	35%	35%
341	Catalytic Heater	12	6	0.498	50%	51%
341	Gas Pipeline Header	12	4	0.334	75%	75%
341	Production Tank (fixed roof)	12	13	1.076	92%	132%

Table 3: Average (mean) process equipment counts and confidence intervals per facility subtype.

Facility SubType Code	Process Equipment Type	Facility SubType Count	Process Equipment Count	Average Equipment Count	95% Confidence Limit (% of mean)	
					lower	upper
341	Propane Fuel Tank	12	1	0.084	100%	198%
341	Screw Compressor	12	7	0.583	43%	43%
341	Tank Heater	12	9	0.748	78%	90%
342	Catalytic Heater	13	1	0.078	100%	197%
342	Heavy Liquid Pipeline Header	13	2	0.154	100%	150%
342	Production Tank (fixed roof)	13	20	1.540	25%	35%
342	Propane Fuel Tank	13	36	2.776	50%	55%
342	Screw Compressor	13	14	1.076	21%	22%
342	Tank Heater	13	20	1.540	35%	45%
361	Catalytic Heater	29	14	0.481	57%	65%
361	Flare KnockOut Drum	29	1	0.035	100%	199%
361	Gas Pipeline Header	29	5	0.172	80%	80%
361	Pig Trap (Gas Service)	29	7	0.241	71%	86%
361	Pop Tank	29	1	0.034	100%	204%
361	Production Tank (fixed roof)	29	8	0.276	63%	75%
361	Reciprocating Compressor	29	2	0.069	100%	152%
361	Separator	29	6	0.207	67%	67%
362	Catalytic Heater	12	25	2.081	60%	68%
362	Flare KnockOut Drum	12	2	0.167	100%	199%
362	Gas Pipeline Header	12	4	0.332	75%	76%
362	Pig Trap (Gas Service)	12	7	0.587	86%	99%
362	Production Tank (fixed roof)	12	5	0.415	100%	141%
362	Reciprocating Compressor	12	1	0.083	100%	201%
362	Separator	12	10	0.835	50%	60%
362	Tank Heater	12	2	0.165	100%	203%
363	Catalytic Heater	11	5	0.453	100%	141%
363	Gas Meter Building	11	1	0.092	100%	195%
363	Gas Pipeline Header	11	3	0.271	100%	101%
363	Separator	11	3	0.274	100%	99%
364	Catalytic Heater	20	65	3.256	77%	123%
364	Flare KnockOut Drum	20	3	0.150	100%	167%
364	Gas Pipeline Header	20	14	0.700	50%	50%
364	Gas Sweetening: Amine	20	2	0.100	100%	201%
364	Pig Trap (Gas Service)	20	10	0.498	70%	81%
364	Power Generator (natural gas fired)	20	2	0.099	100%	151%
364	Production Tank (fixed roof)	20	6	0.299	83%	101%
364	Reciprocating Compressor	20	5	0.246	100%	205%
364	Screw Compressor	20	5	0.249	80%	81%
364	Separator	20	13	0.650	62%	92%

Table 3: Average (mean) process equipment counts and confidence intervals per facility subtype.

Facility SubType Code	Process Equipment Type	Facility SubType Count	Process Equipment Count	Average Equipment Count	95% Confidence Limit (% of mean)	
					lower	upper
364	Storage Bullet	20	2	0.100	100%	201%
601	Catalytic Heater	16	43	2.689	44%	51%
601	Flare KnockOut Drum	16	1	0.063	100%	200%
601	Gas Pipeline Header	16	5	0.314	60%	79%
601	Gas Sample and Analysis System	16	1	0.062	100%	203%
601	Pig Trap (Gas Service)	16	5	0.312	100%	140%
601	Pop Tank	16	1	0.062	100%	204%
601	Production Tank (fixed roof)	16	3	0.188	100%	100%
601	Reciprocating Compressor	16	13	0.817	54%	68%
601	Reciprocating Compressor - Electric Driver	16	1	0.062	100%	202%
601	Screw Compressor	16	7	0.438	57%	57%
601	Separator	16	12	0.748	58%	76%
611	Catalytic Heater	4	1	0.249	100%	201%
611	Flare KnockOut Drum	4	1	0.254	100%	195%
611	Gas Meter Building	4	1	0.253	100%	197%
611	LACT Unit	4	4	0.990	100%	203%
611	Liquid Pump	4	3	0.751	100%	100%
611	Pig Trap (Gas Service)	4	1	0.251	100%	199%
611	Pop Tank	4	2	0.500	100%	100%
611	Production Tank (fixed roof)	4	14	3.503	43%	64%
611	Screw Compressor - Electric Driver	4	3	0.752	100%	199%
611	Scrubber	4	2	0.501	100%	99%
611	Separator	4	2	0.498	100%	101%
611	Treater	4	4	1.000		
621	Catalytic Heater	34	69	2.026	48%	55%
621	Flare KnockOut Drum	34	7	0.205	57%	72%
621	Gas Meter Building	34	5	0.148	80%	99%
621	Gas Pipeline Header	34	28	0.824	25%	25%
621	Liquid Pump	34	1	0.030	100%	194%
621	Pig Trap (Gas Service)	34	12	0.353	67%	92%
621	Pig Trap (Liquid Service)	34	3	0.088	100%	166%
621	Process Boiler	34	1	0.030	100%	194%
621	Production Tank (fixed roof)	34	11	0.325	64%	72%
621	Reciprocating Compressor	34	24	0.709	46%	54%
621	Reciprocating Compressor - Electric Driver	34	6	0.176	83%	100%
621	Screw Compressor	34	2	0.059	100%	147%
621	Screw Compressor - Electric Driver	34	2	0.059	100%	150%

Table 3: Average (mean) process equipment counts and confidence intervals per facility subtype.

Facility SubType Code	Process Equipment Type	Facility SubType Count	Process Equipment Count	Average Equipment Count	95% Confidence Limit (% of mean)	
					lower	upper
621	Separator	34	30	0.884	30%	33%

Well Status Code	Process Equipment Type	Well Status Count	Process Equipment Count	Average Equipment Count	95% Confidence Limit (% of mean)	
					lower	upper
CBMCLS FLOW	Catalytic Heater	14	7	0.502	57%	57%
CBMCLS FLOW	Pig Trap (Gas Service)	14	5	0.355	80%	101%
CBMCLS FLOW	Wellhead (CBM Flow)	14	13	0.929	15%	8%
CBMOT FLOW	Catalytic Heater	21	6	0.286	67%	67%
CBMOT FLOW	Pig Trap (Gas Service)	21	1	0.048	100%	197%
CBMOT FLOW	Wellhead (CBM Flow)	21	21	1.000		
CBMOT PUMP	Pig Trap (Gas Service)	1	1	1.000		
CBMOT PUMP	Wellhead (Gas Pump)	1	1	1.000		
CR-BIT ABZONE	Well Pump	1	1	1.000		
CR-BIT ABZONE	Wellhead (Bitumen Pump)	1	1	1.000		
CR-BIT PUMP	Catalytic Heater	85	1	0.012	100%	200%
CR-BIT PUMP	Gas Pipeline Header	85	1	0.012	100%	197%
CR-BIT PUMP	Production Tank (fixed roof)	85	30	0.352	30%	34%
CR-BIT PUMP	Propane Fuel Tank	85	15	0.177	60%	73%
CR-BIT PUMP	Screw Compressor	85	2	0.023	100%	151%
CR-BIT PUMP	Tank Heater	85	28	0.330	32%	36%
CR-BIT PUMP	Well Pump	85	69	0.812	10%	10%
CR-BIT PUMP	Wellhead (Bitumen Pump)	85	84	0.988	2%	1%
CR-BIT SUSP	Well Pump	2	2	1.000		
CR-BIT SUSP	Wellhead (Bitumen Pump)	2	2	1.000		
CR-OIL FLOW	Catalytic Heater	21	6	0.286	83%	100%
CR-OIL FLOW	Production Tank (fixed roof)	21	1	0.047	100%	202%
CR-OIL FLOW	Separator	21	4	0.191	75%	99%
CR-OIL FLOW	Well Pump	21	2	0.096	100%	149%
CR-OIL FLOW	Wellhead (Oil Flow)	21	21	1.000		
CR-OIL PUMP	Catalytic Heater	103	47	0.456	34%	38%

Well Status Code	Process Equipment Type	Well Status Count	Process Equipment Count	Average Equipment Count	95% Confidence Limit (% of mean)	
					lower	upper
CR-OIL PUMP	Gas Pipeline Header	103	2	0.019	100%	150%
CR-OIL PUMP	Gas Sample and Analysis System	103	1	0.010	100%	202%
CR-OIL PUMP	Liquid Pipeline Header	103	1	0.010	100%	199%
CR-OIL PUMP	Pig Trap (Gas Service)	103	2	0.019	100%	151%
CR-OIL PUMP	Pig Trap (Liquid Service)	103	14	0.136	43%	50%
CR-OIL PUMP	Pop Tank	103	7	0.068	57%	71%
CR-OIL PUMP	Production Tank (fixed roof)	103	20	0.194	40%	45%
CR-OIL PUMP	Propane Fuel Tank	103	1	0.010	100%	198%
CR-OIL PUMP	Screw Compressor	103	3	0.029	100%	134%
CR-OIL PUMP	Scrubber	103	1	0.010	100%	201%
CR-OIL PUMP	Separator	103	28	0.272	32%	36%
CR-OIL PUMP	Well Pump	103	24	0.232	33%	38%
CR-OIL PUMP	Wellhead (Oil Pump)	103	103	1.000		
GAS FLOW	Catalytic Heater	127	112	0.882	20%	20%
GAS FLOW	Flare KnockOut Drum	127	1	0.008	100%	195%
GAS FLOW	Gas Meter Building	127	7	0.055	71%	85%
GAS FLOW	Gas Pipeline Header	127	5	0.039	80%	100%
GAS FLOW	Line Heater	127	1	0.008	100%	200%
GAS FLOW	Pig Trap (Gas Service)	127	9	0.071	55%	67%
GAS FLOW	Pop Tank	127	1	0.008	100%	198%
GAS FLOW	Production Tank (fixed roof)	127	27	0.213	33%	37%
GAS FLOW	Reciprocating Compressor	127	2	0.016	100%	147%
GAS FLOW	Separator	127	57	0.449	19%	19%
GAS FLOW	Wellhead (Gas Flow)	127	127	1.000		
GAS PUMP	Catalytic Heater	62	93	1.502	17%	18%
GAS PUMP	Flare KnockOut Drum	62	1	0.016	100%	205%

Table 4: Average (mean) process equipment counts and confidence intervals per well status.						
Well Status Code	Process Equipment Type	Well Status Count	Process Equipment Count	Average Equipment Count	95% Confidence Limit (% of mean)	
					lower	upper
GAS PUMP	Gas Pipeline Header	62	3	0.049	100%	132%
GAS PUMP	Pig Trap (Gas Service)	62	3	0.049	100%	164%
GAS PUMP	Production Tank (fixed roof)	62	20	0.322	35%	35%
GAS PUMP	Propane Fuel Tank	62	1	0.016	100%	196%
GAS PUMP	Separator	62	33	0.532	24%	24%
GAS PUMP	Wellhead (Gas Pump)	62	61	0.984	3%	2%
GAS STORG	Separator	2	1	0.499	100%	100%
GAS STORG	Wellhead (Gas Storage)	2	2	1.000		
SHG FLOW	Catalytic Heater	1	1	1.000		
SHG FLOW	Separator	1	1	1.000		
SHG FLOW	Wellhead (Gas Flow)	1	1	1.000		

3.2 COMPONENT COUNTS

Components in pressurized hydrocarbon service, greater than 0.5” nominal pipe size (NPS) and belonging to the process equipment described in Section 3.1 were counted and classified according to the following component types and hydrocarbon service types. More than 216,000 components were counted during the 2017 field campaign. A definition for each component type is presented in Section 8.3 and for each service type in Section 8.2.

- Reciprocating Compressor Rod-Packing,
- Centrifugal Compressor Seals¹⁹,
- Connector,
- Control Valve,
- Meter,
- Open-Ended Line,
- Pressure Relief Valves and Pressure Safety Valves (PRV/PSV),
- Pump Seal,
- Regulator,
- Thief Hatch,
- Valve, and
- Well Surface Casing Vent (SCVF).

The list of component types is adopted from previous Canadian UOG emission factor publications (CAPP, 2005 and CAPP, 2014) and extended to include meters, thief hatches and SCVF. Meters are included as a convenience to mitigate field component counting effort. The thief hatch and SCVF component types are added because their emission release characteristics are poorly represented by other component types. Historically, thief hatches were counted as a connector while SCVF lines were not considered because they are regulated by AER [Interim Directive 2003-01](#) (or incorrectly counted as open-ended lines²⁰). Because the leaker and population leak factors presented below for thief hatches and SCVFs are different than connectors and open-ended lines, separate components types are justifiable.

Reciprocating compressor rod-packings in good condition are intended to release gas and are therefore defined in Draft Directive 060 as a vent (AER, 2018). However, as they wear, the release rate increases and eventually becomes a leak. To simplify data analysis and presentation of results, rod-packings are defined as leak source throughout this report (but should be defined as a vent source with respect to Directive 060 applications).

¹⁹ No centrifugal compressors were observed during the 2017 surveys. They are typically used at gas transmission stations which were not included in the 2017 survey plan.

²⁰ As defined in Section 8.3.6, open-ended lines feature a closed valve upstream of the open end which is not the case for SCVF lines (unless a valve was installed on the SCVF line and leakage occurred past the closed valve).

Subsequent analysis of the data collected observed no statistical difference in leak factors between components in fuel versus process gas service. Therefore, there is little value differentiating between the service types and subject records are assigned to a single service type (process gas). This consolidation is consistent with the methodology used in other fugitive emission factor publications (CAPP, 2014 and EPA, 2016). Differences are observed between gas and liquid service leak factors so liquid service types are retained.

Average (mean) component counts are calculated for each process equipment type using Equation 7 and are presented in Table 5: Average component counts (mean) and confidence intervals per process equipment type.. Confidence intervals are determined according to Section 3.7 for each component record and also presented in Table 5: Average component counts (mean) and confidence intervals per process equipment type.. These component schedules will be used to estimate the number of potential equipment leak sources for the Alberta UOG industry.

$$\bar{N}_{CC} = \frac{N_{CC}}{N_{PE}}$$

Equation 7

Where,

\bar{N}_{CC} = average component count for a given service and process equipment type,
 N_{CC} = total number of components surveyed for a service and process equipment type,
 N_{PE} = total number of units for a given process equipment type.

Process Equipment Type	Component Type	Service Type	Process Equipment Count	Total Component Count	Average Component Count	95% Confidence Limit (% of mean)	
						lower	upper
Catalytic Heater	Regulator	Process Gas	651	721	1.159	7%	8%
Catalytic Heater	Valve	Process Gas	651	745	1.197	9%	11%
Catalytic Heater	Connector	Process Gas	651	756	1.212	29%	32%
Dehydrator - Glycol	Control Valve	Process Gas	20	25	1.310	58%	71%
Dehydrator - Glycol	Valve	Process Gas	20	576	30.118	37%	47%
Dehydrator - Glycol	Valve	Light Liquid	20	29	1.528	88%	136%
Dehydrator - Glycol	Meter	Process Gas	20	22	1.153	41%	47%
Dehydrator - Glycol	Control Valve	Light Liquid	20	6	0.312	98%	141%
Dehydrator - Glycol	Open-Ended Line	Process Gas	20	8	0.416	97%	151%
Dehydrator - Glycol	Regulator	Process Gas	20	104	5.457	42%	48%
Dehydrator - Glycol	Connector	Process Gas	20	4130	215.836	35%	39%
Dehydrator - Glycol	Connector	Light Liquid	20	227	11.980	88%	137%
Dehydrator - Glycol	PRV/PSV	Process Gas	20	50	2.621	40%	49%
Flare KnockOut Drum	Valve	Process Gas	29	244	8.844	56%	90%
Flare KnockOut Drum	Meter	Process Gas	29	1	0.036	100%	308%
Flare KnockOut Drum	Control Valve	Process Gas	29	5	0.181	96%	141%
Flare KnockOut Drum	Regulator	Process Gas	29	30	1.083	57%	71%
Flare KnockOut Drum	Control Valve	Light Liquid	29	1	0.036	100%	308%
Flare KnockOut Drum	Connector	Process Gas	29	1516	54.764	45%	58%
Flare KnockOut Drum	Connector	Light Liquid	29	530	19.086	48%	59%
Flare KnockOut Drum	Valve	Light Liquid	29	84	3.036	51%	64%
Flare KnockOut Drum	PRV/PSV	Process Gas	29	5	0.180	100%	169%
Flare KnockOut Drum	Open-Ended Line	Light Liquid	29	19	0.684	100%	291%
Gas Boot	Valve	Process Gas	3	3	1.042	100%	163%
Gas Boot	Valve	Light Liquid	3	20	6.944	77%	103%
Gas Boot	Connector	Light Liquid	3	77	26.739	76%	87%

Process Equipment Type	Component Type	Service Type	Process Equipment Count	Total Component Count	Average Component Count	95% Confidence Limit (% of mean)	
						lower	upper
Gas Boot	PRV/PSV	Process Gas	3	1	0.348	100%	263%
Gas Boot	Connector	Process Gas	3	15	5.178	76%	92%
Gas Meter Building	Valve	Process Gas	14	255	19.100	50%	64%
Gas Meter Building	Valve	Light Liquid	14	12	0.891	100%	299%
Gas Meter Building	Meter	Process Gas	14	18	1.352	54%	81%
Gas Meter Building	Meter	Light Liquid	14	4	0.296	100%	316%
Gas Meter Building	Control Valve	Process Gas	14	7	0.529	93%	124%
Gas Meter Building	Regulator	Process Gas	14	22	1.643	79%	107%
Gas Meter Building	Connector	Process Gas	14	1277	95.873	54%	69%
Gas Meter Building	Connector	Light Liquid	14	76	5.618	100%	309%
Gas Meter Building	Open-Ended Line	Process Gas	14	2	0.149	100%	305%
Gas Meter Building	PRV/PSV	Process Gas	14	15	1.118	72%	100%
Gas Pipeline Header	Valve	Process Gas	82	2346	29.916	31%	38%
Gas Pipeline Header	Valve	Light Liquid	82	123	1.604	98%	183%
Gas Pipeline Header	Meter	Process Gas	82	40	0.511	65%	96%
Gas Pipeline Header	Control Valve	Process Gas	82	34	0.436	71%	133%
Gas Pipeline Header	Connector	Process Gas	82	8289	105.826	33%	40%
Gas Pipeline Header	Connector	Light Liquid	82	487	6.272	100%	234%
Gas Pipeline Header	Open-Ended Line	Process Gas	82	5	0.063	100%	169%
Gas Pipeline Header	PRV/PSV	Process Gas	82	26	0.334	61%	83%
Gas Pipeline Header	Regulator	Process Gas	82	60	0.761	70%	115%
Gas Sweetening: Amine	Valve	Process Gas	3	106	37.046	90%	194%
Gas Sweetening: Amine	Valve	Light Liquid	3	3	1.046	75%	86%
Gas Sweetening: Amine	Regulator	Process Gas	3	3	1.042	75%	84%
Gas Sweetening: Amine	Connector	Process Gas	3	253	87.596	76%	100%
Gas Sweetening: Amine	Connector	Light Liquid	3	9	3.126	85%	127%

Process Equipment Type	Component Type	Service Type	Process Equipment Count	Total Component Count	Average Component Count	95% Confidence Limit (% of mean)	
						lower	upper
Gas Sweetening: Amine	PRV/PSV	Process Gas	3	2	0.691	100%	264%
Heavy Liquid Pipeline Header	Valve	Heavy Liquid	2	24	12.388	95%	186%
Heavy Liquid Pipeline Header	Connector	Heavy Liquid	2	56	29.379	91%	129%
Incinerator	Valve	Process Gas	1	8	8.404	100%	153%
Incinerator	Regulator	Process Gas	1	3	3.137	100%	151%
Incinerator	Control Valve	Process Gas	1	2	2.098	100%	150%
Incinerator	Connector	Process Gas	1	53	56.333	100%	147%
LACT Unit	Valve	Process Gas	4	2	0.528	100%	158%
LACT Unit	Valve	Light Liquid	4	102	26.675	68%	82%
LACT Unit	Meter	Light Liquid	4	14	3.701	84%	125%
LACT Unit	Control Valve	Process Gas	4	3	0.787	100%	184%
LACT Unit	Control Valve	Light Liquid	4	10	2.602	78%	115%
LACT Unit	Connector	Process Gas	4	92	23.527	100%	161%
LACT Unit	Connector	Light Liquid	4	469	123.323	72%	94%
LACT Unit	PRV/PSV	Process Gas	4	2	0.525	100%	271%
LACT Unit	PRV/PSV	Light Liquid	4	2	0.520	100%	276%
Line Heater	Valve	Process Gas	11	127	12.129	60%	101%
Line Heater	Control Valve	Process Gas	11	3	0.286	100%	207%
Line Heater	Valve	Light Liquid	11	28	2.663	81%	121%
Line Heater	Meter	Process Gas	11	2	0.193	100%	188%
Line Heater	Regulator	Process Gas	11	41	3.885	55%	70%
Line Heater	Connector	Process Gas	11	1082	103.033	51%	69%
Line Heater	Connector	Light Liquid	11	124	11.812	80%	106%
Line Heater	PRV/PSV	Process Gas	11	7	0.659	84%	131%
Liquid Pipeline Header	Meter	Light Liquid	33	1	0.031	100%	311%
Liquid Pipeline Header	Valve	Light Liquid	33	1066	33.770	33%	41%

Process Equipment Type	Component Type	Service Type	Process Equipment Count	Total Component Count	Average Component Count	95% Confidence Limit (% of mean)	
						lower	upper
Liquid Pipeline Header	Control Valve	Light Liquid	33	14	0.438	100%	168%
Liquid Pipeline Header	Connector	Light Liquid	33	3734	118.561	32%	36%
Liquid Pump	Valve	Process Gas	14	9	0.673	100%	302%
Liquid Pump	Valve	Light Liquid	14	203	15.162	51%	70%
Liquid Pump	Meter	Light Liquid	14	6	0.454	81%	116%
Liquid Pump	Pump Seal	Light Liquid	14	14	1.045	37%	39%
Liquid Pump	Connector	Light Liquid	14	819	61.322	44%	57%
Liquid Pump	Connector	Process Gas	14	60	4.606	100%	297%
Liquid Pump	PRV/PSV	Light Liquid	14	8	0.595	70%	87%
Pig Trap (Gas Service)	Valve	Process Gas	74	574	8.106	25%	33%
Pig Trap (Gas Service)	Connector	Process Gas	74	1565	22.153	27%	35%
Pig Trap (Gas Service)	PRV/PSV	Process Gas	74	2	0.029	100%	207%
Pig Trap (Liquid Service)	Valve	Light Liquid	31	153	5.137	34%	40%
Pig Trap (Liquid Service)	Connector	Light Liquid	31	508	17.157	31%	34%
Pop Tank	Valve	Light Liquid	20	25	1.311	50%	64%
Pop Tank	Connector	Process Gas	20	45	2.356	92%	176%
Pop Tank	Connector	Light Liquid	20	110	5.765	53%	66%
Pop Tank	Open-Ended Line	Light Liquid	20	19	0.998	36%	41%
Power Generator (natural gas fired)	Valve	Process Gas	3	32	11.179	94%	137%
Power Generator (natural gas fired)	Control Valve	Process Gas	3	2	0.688	100%	272%
Power Generator (natural gas fired)	Regulator	Process Gas	3	9	3.157	86%	153%
Power Generator (natural gas fired)	Connector	Process Gas	3	301	103.754	98%	143%
Process Boiler	Valve	Process Gas	1	15	15.725	100%	150%
Process Boiler	Regulator	Process Gas	1	4	4.224	100%	148%
Process Boiler	Connector	Process Gas	1	64	66.510	100%	150%
Process Boiler	PRV/PSV	Process Gas	1	1	1.039	100%	155%

Table 5: Average component counts (mean) and confidence intervals per process equipment type.							
Process Equipment Type	Component Type	Service Type	Process Equipment Count	Total Component Count	Average Component Count	95% Confidence Limit (% of mean)	
						lower	upper
Production Tank (fixed roof - heavy oil)	Open-Ended Line	Heavy Liquid	63	1	0.017	100%	319%
Production Tank (fixed roof - heavy oil)	PRV/PSV	Process Gas	63	1	0.017	100%	317%
Production Tank (fixed roof - heavy oil)	Connector	Heavy Liquid	63	2280	37.905	22%	24%
Production Tank (fixed roof - heavy oil)	Valve	Heavy Liquid	63	857	14.218	19%	20%
Production Tank (fixed roof - Light/Medium Oil)	Valve	Process Gas	213	88	0.431	37%	46%
Production Tank (fixed roof - Light/Medium Oil)	Thief Hatch	Light Liquid	213	82	0.399	83%	229%
Production Tank (fixed roof - Light/Medium Oil)	Thief Hatch	Process Gas	213	50	0.246	31%	34%
Production Tank (fixed roof - Light/Medium Oil)	Valve	Light Liquid	213	1087	5.340	17%	21%
Production Tank (fixed roof - Light/Medium Oil)	Regulator	Process Gas	213	49	0.241	30%	33%
Production Tank (fixed roof - Light/Medium Oil)	Connector	Process Gas	213	785	3.850	36%	46%
Production Tank (fixed roof - Light/Medium Oil)	Connector	Light Liquid	213	4444	21.815	14%	15%
Production Tank (fixed roof - Light/Medium Oil)	Open-Ended Line	Process Gas	213	3	0.015	100%	166%
Production Tank (fixed roof - Light/Medium Oil)	PRV/PSV	Light Liquid	213	1	0.005	100%	297%
Production Tank (fixed roof - Light/Medium Oil)	PRV/PSV	Process Gas	213	49	0.241	30%	33%

Process Equipment Type	Component Type	Service Type	Process Equipment Count	Total Component Count	Average Component Count	95% Confidence Limit (% of mean)	
						lower	upper
Production Tank (fixed roof - Light/Medium Oil)	Open-Ended Line	Light Liquid	213	3	0.015	100%	239%
Propane Fuel Tank	Valve	Process Gas	56	115	2.148	23%	27%
Propane Fuel Tank	Regulator	Process Gas	56	56	1.045	19%	19%
Propane Fuel Tank	Connector	Process Gas	56	721	13.467	22%	23%
Reciprocating Compressor	Valve	Process Gas	54	1860	35.982	25%	31%
Reciprocating Compressor	Valve	Light Liquid	54	327	6.334	38%	44%
Reciprocating Compressor	Meter	Process Gas	54	15	0.290	56%	66%
Reciprocating Compressor	Control Valve	Light Liquid	54	36	0.699	55%	64%
Reciprocating Compressor	Control Valve	Process Gas	54	110	2.131	33%	37%
Reciprocating Compressor	Regulator	Process Gas	54	293	5.662	31%	36%
Reciprocating Compressor	Compressor Rod-Packing	Process Gas	54	157	3.045	23%	25%
Reciprocating Compressor	Connector	Light Liquid	54	2786	53.869	43%	54%
Reciprocating Compressor	Open-Ended Line	Process Gas	54	28	0.545	67%	90%
Reciprocating Compressor	PRV/PSV	Process Gas	54	190	3.676	24%	26%
Reciprocating Compressor	Connector	Process Gas	54	31600	612.150	22%	23%
Reciprocating Compressor - Electric Driver	Valve	Process Gas	10	175	18.293	53%	65%
Reciprocating Compressor - Electric Driver	Regulator	Process Gas	10	1	0.103	100%	306%
Reciprocating Compressor - Electric Driver	Valve	Light Liquid	10	89	9.387	60%	79%
Reciprocating Compressor - Electric Driver	Meter	Process Gas	10	4	0.417	90%	117%
Reciprocating Compressor - Electric Driver	Control Valve	Process Gas	10	3	0.312	100%	202%

Table 5: Average component counts (mean) and confidence intervals per process equipment type.							
Process Equipment Type	Component Type	Service Type	Process Equipment Count	Total Component Count	Average Component Count	95% Confidence Limit (% of mean)	
						lower	upper
Reciprocating Compressor - Electric Driver	Control Valve	Light Liquid	10	15	1.568	79%	102%
Reciprocating Compressor - Electric Driver	Connector	Process Gas	10	3933	412.058	45%	51%
Reciprocating Compressor - Electric Driver	Compressor Rod-Packing	Process Gas	10	30	3.120	56%	65%
Reciprocating Compressor - Electric Driver	Connector	Light Liquid	10	560	58.561	60%	92%
Reciprocating Compressor - Electric Driver	PRV/PSV	Process Gas	10	23	2.400	46%	54%
Screw Compressor	Valve	Process Gas	46	1124	25.556	31%	38%
Screw Compressor	Valve	Light Liquid	46	200	4.559	55%	74%
Screw Compressor	Meter	Process Gas	46	43	0.976	37%	41%
Screw Compressor	Control Valve	Process Gas	46	50	1.135	44%	54%
Screw Compressor	Control Valve	Light Liquid	46	7	0.159	87%	126%
Screw Compressor	Regulator	Process Gas	46	182	4.135	26%	30%
Screw Compressor	Connector	Process Gas	46	14934	339.208	29%	37%
Screw Compressor	Connector	Light Liquid	46	1559	35.562	53%	71%
Screw Compressor	Open-Ended Line	Process Gas	46	25	0.567	63%	85%
Screw Compressor	PRV/PSV	Process Gas	46	150	3.407	25%	27%
Screw Compressor - Electric Driver	Valve	Process Gas	8	130	17.000	55%	69%
Screw Compressor - Electric Driver	Control Valve	Process Gas	8	9	1.182	88%	118%
Screw Compressor - Electric Driver	Valve	Light Liquid	8	27	3.534	77%	102%
Screw Compressor - Electric Driver	Meter	Process Gas	8	3	0.396	100%	200%
Screw Compressor - Electric Driver	Regulator	Process Gas	8	1	0.132	100%	288%
Screw Compressor - Electric Driver	Connector	Process Gas	8	1582	208.041	58%	77%

Process Equipment Type	Component Type	Service Type	Process Equipment Count	Total Component Count	Average Component Count	95% Confidence Limit (% of mean)	
						lower	upper
Screw Compressor - Electric Driver	Connector	Light Liquid	8	279	36.610	69%	88%
Screw Compressor - Electric Driver	Open-Ended Line	Process Gas	8	2	0.260	100%	188%
Screw Compressor - Electric Driver	PRV/PSV	Process Gas	8	12	1.569	68%	84%
Scrubber	Valve	Process Gas	4	46	12.000	98%	183%
Scrubber	Connector	Process Gas	4	290	76.711	96%	186%
Scrubber	PRV/PSV	Process Gas	4	2	0.522	100%	164%
Separator	Valve	Process Gas	288	5548	20.126	15%	16%
Separator	Control Valve	Process Gas	288	244	0.885	19%	21%
Separator	Valve	Light Liquid	288	3407	12.373	13%	14%
Separator	Meter	Process Gas	288	299	1.085	13%	15%
Separator	Control Valve	Light Liquid	288	200	0.726	19%	22%
Separator	Meter	Light Liquid	288	115	0.417	22%	23%
Separator	Connector	Light Liquid	288	18762	68.110	14%	16%
Separator	Regulator	Process Gas	288	689	2.501	17%	18%
Separator	Connector	Process Gas	288	29929	108.724	11%	12%
Separator	Open-Ended Line	Process Gas	288	33	0.120	51%	60%
Separator	PRV/PSV	Process Gas	288	460	1.670	11%	13%
Storage Bullet	Valve	Light Liquid	2	40	20.924	91%	107%
Storage Bullet	Control Valve	Light Liquid	2	4	2.088	92%	106%
Storage Bullet	Connector	Light Liquid	2	160	83.719	92%	106%
Tank Heater	Valve	Process Gas	60	450	7.847	22%	27%
Tank Heater	Meter	Process Gas	60	1	0.017	100%	307%
Tank Heater	Regulator	Process Gas	60	226	3.939	21%	22%
Tank Heater	Connector	Process Gas	60	3109	54.248	20%	22%
Treater	Valve	Process Gas	24	465	20.286	38%	47%
Treater	Valve	Light Liquid	24	394	17.206	42%	51%

Process Equipment Type	Component Type	Service Type	Process Equipment Count	Total Component Count	Average Component Count	95% Confidence Limit (% of mean)	
						lower	upper
Treater	Meter	Process Gas	24	21	0.916	49%	57%
Treater	Control Valve	Process Gas	24	18	0.783	47%	55%
Treater	Control Valve	Light Liquid	24	23	1.007	52%	63%
Treater	Meter	Light Liquid	24	11	0.477	65%	85%
Treater	Regulator	Process Gas	24	112	4.887	40%	47%
Treater	Connector	Process Gas	24	4548	197.835	34%	38%
Treater	Connector	Light Liquid	24	2181	95.200	39%	47%
Treater	Open-Ended Line	Process Gas	24	5	0.216	100%	304%
Treater	Open-Ended Line	Light Liquid	24	14	0.612	100%	212%
Treater	PRV/PSV	Process Gas	24	36	1.571	42%	54%
Well Pump	Valve	Process Gas	98	591	6.305	18%	20%
Well Pump	Regulator	Process Gas	98	191	2.036	17%	18%
Well Pump	PRV/PSV	Process Gas	98	28	0.300	40%	45%
Well Pump	Connector	Process Gas	98	4781	51.104	18%	19%
Wellhead (Bitumen Pump)	Valve	Heavy Liquid	87	747	8.983	17%	18%
Wellhead (Bitumen Pump)	Valve	Process Gas	87	630	7.573	18%	20%
Wellhead (Bitumen Pump)	Connector	Heavy Liquid	87	3025	36.393	18%	19%
Wellhead (Bitumen Pump)	Regulator	Process Gas	87	39	0.469	34%	38%
Wellhead (Bitumen Pump)	Open-Ended Line	Process Gas	87	12	0.144	59%	71%
Wellhead (Bitumen Pump)	Connector	Process Gas	87	2307	27.725	20%	21%
Wellhead (Bitumen Pump)	PRV/PSV	Process Gas	87	24	0.289	43%	46%
Wellhead (CBM Flow)	Valve	Process Gas	34	331	10.167	32%	48%
Wellhead (CBM Flow)	Meter	Process Gas	34	8	0.245	69%	87%
Wellhead (CBM Flow)	Regulator	Process Gas	34	2	0.063	100%	196%
Wellhead (CBM Flow)	Connector	Process Gas	34	1024	31.475	28%	32%
Wellhead (CBM Flow)	Open-Ended Line	Process Gas	34	10	0.307	62%	75%

Process Equipment Type	Component Type	Service Type	Process Equipment Count	Total Component Count	Average Component Count	95% Confidence Limit (% of mean)	
						lower	upper
Wellhead (CBM Flow)	PRV/PSV	Process Gas	34	2	0.062	100%	198%
Wellhead (Gas Flow)	Valve	Process Gas	128	1543	12.613	17%	18%
Wellhead (Gas Flow)	Meter	Process Gas	128	8	0.065	72%	92%
Wellhead (Gas Flow)	Regulator	Process Gas	128	50	0.417	95%	263%
Wellhead (Gas Flow)	Open-Ended Line	Process Gas	128	1	0.008	100%	312%
Wellhead (Gas Flow)	PRV/PSV	Process Gas	128	6	0.049	82%	107%
Wellhead (Gas Flow)	Connector	Process Gas	128	5383	43.948	16%	18%
Wellhead (Gas Pump)	Valve	Process Gas	62	855	14.435	23%	27%
Wellhead (Gas Pump)	Meter	Process Gas	62	20	0.336	45%	50%
Wellhead (Gas Pump)	Regulator	Process Gas	62	33	0.557	54%	71%
Wellhead (Gas Pump)	Connector	Process Gas	62	4300	72.591	24%	28%
Wellhead (Gas Pump)	Open-Ended Line	Process Gas	62	2	0.034	100%	208%
Wellhead (Gas Pump)	PRV/PSV	Process Gas	62	27	0.456	51%	60%
Wellhead (Gas Storage)	Valve	Process Gas	2	18	9.340	93%	135%
Wellhead (Gas Storage)	Connector	Process Gas	2	59	30.684	92%	103%
Wellhead (Oil Flow)	Valve	Process Gas	21	250	12.417	58%	74%
Wellhead (Oil Flow)	Meter	Process Gas	21	1	0.050	100%	314%
Wellhead (Oil Flow)	Valve	Light Liquid	21	139	6.915	49%	57%
Wellhead (Oil Flow)	Connector	Process Gas	21	714	35.342	55%	70%
Wellhead (Oil Flow)	Connector	Light Liquid	21	623	31.109	51%	58%
Wellhead (Oil Pump)	Valve	Process Gas	103	385	3.918	35%	39%
Wellhead (Oil Pump)	Valve	Light Liquid	103	990	10.038	19%	21%
Wellhead (Oil Pump)	Meter	Process Gas	103	2	0.020	100%	212%
Wellhead (Oil Pump)	Regulator	Process Gas	103	11	0.112	71%	93%
Wellhead (Oil Pump)	Open-Ended Line	Process Gas	103	1	0.010	100%	306%
Wellhead (Oil Pump)	Connector	Process Gas	103	1793	18.177	34%	39%

Table 5: Average component counts (mean) and confidence intervals per process equipment type.							
Process Equipment Type	Component Type	Service Type	Process Equipment Count	Total Component Count	Average Component Count	95% Confidence Limit (% of mean)	
						lower	upper
Wellhead (Oil Pump)	Connector	Light Liquid	103	4847	49.139	19%	20%
Wellhead (Oil Pump)	Pump Seal	Light Liquid	103	103	1.047	14%	14%
Wellhead (Oil Pump)	PRV/PSV	Process Gas	103	4	0.041	100%	180%

3.3 EMISSION CONTROLS

In addition to counting components, the following emission controls were noted by field inspectors when installed on subject process equipment units.

- Gas Conserved – where natural gas is captured and sold, used as fuel, injected into reservoirs for pressure maintenance or other beneficial purpose.
- Gas tied to flare – where natural gas is captured and disposed by thermal oxidization in a flare or incinerator.
- Gas tied to scrubber – where natural gas is captured and specific substances of concern (e.g., H₂S or other odorous compounds) are removed via adsorption or catalytic technologies.

Common examples of emission control include storage tanks that are ‘blanketed’ with natural gas and connected to a flare header (“Gas Flared”) or vapour recovery unit (“Gas Conserved”). Another example are reciprocating compressor rod-packing vents tied into the flare header (“Gas Flared”) or captured by a Remvue slipstream and used as fuel (“Gas Conserved”). Additional details regarding the motivating factors (e.g., H₂S content or odour of vapours, corporate emission reduction objectives or incentives, etc) were not collected.

The average emission control per equipment unit, determined using Equation 8, considers the frequency controls observed plus the estimated control efficiency for preventing the release of natural gas to the atmosphere (i.e., how much of the subject gas stream is captured and combusted/conserved over an extended period of time). Because control efficiency assessment was beyond the scope of the 2017 field campaign, a conservative estimate of 95 percent is adopted for conservation and flaring (CCME, 1995²¹) while scrubbers are assigned 0 control because they prevent very little of subject natural gas streams from being released to atmosphere.

$$EC = \eta \cdot \frac{N_{CD}}{N_{PU}}$$

Equation 8

Where,

- EC = average (mean) emission control per process equipment unit,
η = efficiency of control device to prevent preventing the release of natural gas to the atmosphere (0.95 for conservation and flares. 0 for scrubbers),
N_{CD} = total number of process units with a control device,
N_{PU} = total number of process units surveyed.

21 This is the minimum performance required by CCME (1995) for vapour control systems.

Results in Table 6 provide perspective regarding the proliferation of emission controls for storage tanks and reciprocating compressor rod-packings located at sites upstream of gas plants. Application of these factors to large equipment populations will produce representative emission results, however, this is not true if applied to individual or small populations of equipment. Other efforts to control emissions are discussed in Section 3.4 (e.g., distribution of air versus natural gas driven pneumatics), Section 4.4 (e.g., leak factor trends) and are not amenable to determining convenient control factors presented in Table 6. Efforts to capture and control emission from individual dehydrators are known via Directive 039 reporting (AER, 2017) so a control factor is not necessary.

Table 6: Average (mean) emission control and confidence interval per process equipment unit.

Description of Control	Process Equipment Count	Control Count	Average Control Factor	95% Confidence Interval (%of mean)	
				Lower	Upper
Storage tank tied into flare or conserved	213	46	0.21	28%	31%
Storage tank tied into scrubber	213	3	0.00	-	-
Compressor rod-packing vent tied into flare or conserved	54	7	0.12	65%	72%
Pop tank tied into flare or conserved	20	2	0.10	100%	123%

3.4 PNEUMATIC DEVICE COUNTS

Pneumatic devices driven by natural gas, propane, instrument air and electricity²² were inventoried at each location surveyed in 2017. To increase the sample size, pneumatic inventory data collected in 2016 by Greenpath Energy Ltd. for the AER was considered for this assessment (Greenpath, 2017a). Devices are included in the results below when sufficient information was available to assign 2016 records to a Facility ID or UWI. In cases where multiple Facility ID were active at a single location or insufficient UWI details available, the 2016 record was omitted from the sample because a definitive relation between the device and facility subtype or well status could not be established. Overall, 1,105 of 1,688 pneumatic devices from the 2016 dataset are included in this study. The 2016 records included in this study represent 6 Facility IDs and 197 wells.

Devices that provide the following control actions are the dominant contributors to pneumatic venting emissions and account for 2,289 of the 2,858 pneumatic devices observed during 2016 and 2017 surveys. Figure 4 delineates the pneumatic inventory by device type and driver type.

²² The majority of electric driven devices are solar powered chemical injection pumps. However, a small number of pneumatic instruments were observed to be electric powered.

The majority of devices are driven by natural gas while approximately 30 percent of devices utilize alternative drivers (instrument air, propane or electricity) that do not directly contribute to methane emissions.

- Level Controller
- Positioner
- Pressure Controller
- Chemical Pump
- Transducer

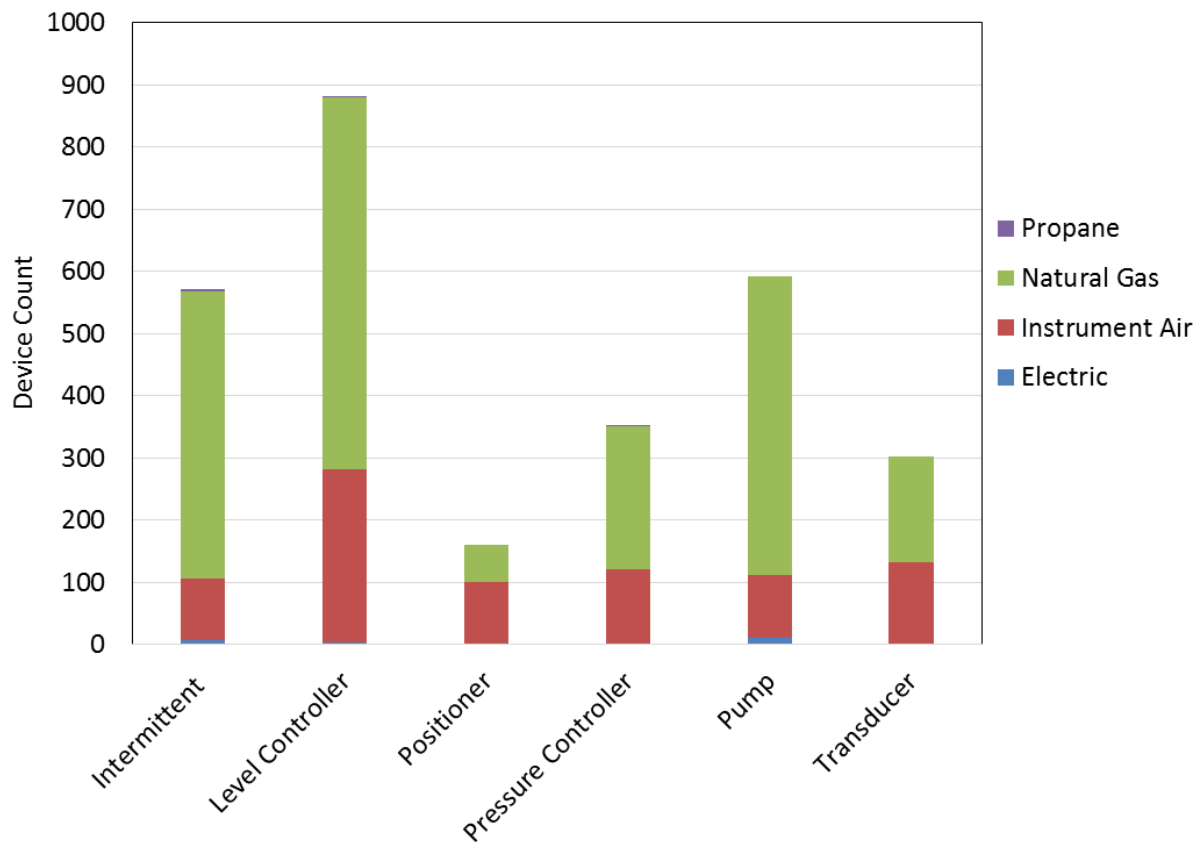

Figure 4: Pneumatic counts, by device type and driver type, observed at Alberta UOG facilities and wells during 2016 and 2017 field campaigns.

Devices that provide the following control actions typically vent at rates well below 0.17 m³ per hour or only during infrequent unloading (de-energizing) events. Therefore, subject models are aggregated and presented as device type “Intermittent” in report tables. This simplifies emission inventory development efforts and is reasonable for devices that contributes very little to total methane emissions.

- High Level Shut Down

- High Pressure Shut Down
- Level Switch
- Plunger Lift Controller
- Pressure Switch
- Temperature Switch

Instances of continuous venting (greater than 0.17 m³ per hour) may occur for these control actions but they should be limited to malfunctioning, improperly calibrated or improperly installed devices. Collecting a complete inventory of intermittent-bleed devices was a lower priority for field technicians because their contribution to the total volume of gas vented by pneumatic devices is much less than continuous-bleed devices and pumps. Moreover, isolation-valve actuators were not inventoried because gas release events are infrequent. Therefore, counts presented in Figure 4 likely understate the number of intermittent devices operating in the UOG industry.

The average (mean) number of pneumatic devices per facility subtype and well status are presented in Table 7 and Table 8 according to device (e.g., level controllers, positioners, pressure controllers, transducers, chemical pumps and intermittent) and driver type (e.g., instrument air, propane and electric). The mean is calculated using Equation 6 but divides the total number of devices belonging to the subject category and observed at the subject facility subtype or well status code (e.g., count of natural gas driven transducers at compressor stations) by the total number of corresponding facility subtypes or well status codes surveyed (e.g., total count of compressor stations surveyed). The factors for natural gas driven devices should be adopted for GHG emission inventory purposes. Factors for propane (relevant to volatile organic compound (VOC) emissions), instrument air and electric driven devices provide some insight into the installation frequency of non-emitting devices.

There are a number of different pneumatic models commercially available for each device type. The observed pneumatic model distributions for level controllers (882 devices), positioners (160 devices), pressure controllers (351 devices), transducers (303 devices) and chemical pumps (593 devices) are presented in Figure 5, Figure 6, Figure 7, Figure 8 and Figure 9, respectively. Although models are known for each device, the group 'other' is used for device model counts less than 5 to simplify the pie charts below.

Table 7: Average (mean) pneumatic device counts and confidence intervals per facility subtype.							
Facility SubType Code	Pneumatic Device Type	Driver	Facility SubType Count	Pneumatic Device Count	Average Pneumatic Count	95% Confidence Limit (% of mean)	
						lower	upper
321	Intermittent	Natural Gas	10	11	1.156	100%	173%
321	Level Controller	Natural Gas	10	10	1.045	91%	129%
321	Pressure Controller	Natural Gas	10	5	0.522	100%	235%
321	Pump	Natural Gas	10	6	0.622	100%	162%
321	Transducer	Natural Gas	10	1	0.104	100%	293%
322	Intermittent	Instrument Air	33	19	0.601	73%	95%
322	Intermittent	Natural Gas	33	26	0.825	69%	87%
322	Level Controller	Instrument Air	33	99	3.159	59%	74%
322	Level Controller	Natural Gas	33	50	1.581	59%	74%
322	Positioner	Instrument Air	33	10	0.317	91%	133%
322	Positioner	Natural Gas	33	7	0.221	100%	208%
322	Pressure Controller	Instrument Air	33	59	1.870	70%	95%
322	Pressure Controller	Natural Gas	33	20	0.638	67%	88%
322	Pump	Instrument Air	33	15	0.475	93%	173%
322	Pump	Electric	33	1	0.032	100%	313%
322	Pump	Natural Gas	33	13	0.411	75%	101%
322	Transducer	Instrument Air	33	13	0.412	99%	159%
322	Transducer	Natural Gas	33	13	0.411	100%	242%
361	Intermittent	Natural Gas	29	19	0.684	83%	140%
361	Level Controller	Instrument Air	29	2	0.072	100%	308%
361	Level Controller	Natural Gas	29	15	0.537	84%	121%
361	Pressure Controller	Natural Gas	29	3	0.107	100%	219%
361	Pump	Natural Gas	29	12	0.433	79%	102%
362	Intermittent	Natural Gas	12	6	0.524	100%	208%
362	Level Controller	Instrument Air	12	4	0.351	100%	160%

Facility SubType Code	Pneumatic Device Type	Driver	Facility SubType Count	Pneumatic Device Count	Average Pneumatic Count	95% Confidence Limit (% of mean)	
						lower	upper
362	Level Controller	Natural Gas	12	4	0.350	100%	190%
362	Positioner	Instrument Air	12	3	0.261	100%	208%
362	Positioner	Natural Gas	12	1	0.087	100%	313%
362	Pressure Controller	Natural Gas	12	6	0.529	100%	249%
362	Pump	Instrument Air	12	6	0.525	100%	299%
362	Pump	Natural Gas	12	4	0.351	100%	220%
362	Transducer	Instrument Air	12	3	0.262	100%	150%
363	Intermittent	Natural Gas	11	1	0.096	100%	306%
363	Level Controller	Natural Gas	11	5	0.479	100%	183%
363	Pressure Controller	Natural Gas	11	1	0.095	100%	290%
364	Intermittent	Instrument Air	20	11	0.576	100%	245%
364	Intermittent	Natural Gas	20	21	1.092	74%	104%
364	Level Controller	Instrument Air	20	3	0.158	100%	213%
364	Level Controller	Natural Gas	20	11	0.570	83%	129%
364	Positioner	Instrument Air	20	3	0.158	100%	212%
364	Positioner	Natural Gas	20	8	0.420	100%	178%
364	Pressure Controller	Instrument Air	20	3	0.159	100%	299%
364	Pressure Controller	Natural Gas	20	2	0.107	100%	198%
364	Pump	Instrument Air	20	12	0.621	100%	215%
364	Pump	Natural Gas	20	5	0.264	100%	249%
364	Transducer	Instrument Air	20	2	0.106	100%	205%
364	Transducer	Natural Gas	20	3	0.157	100%	209%
601	Intermittent	Instrument Air	16	9	0.583	97%	204%
601	Intermittent	Natural Gas	16	17	1.116	71%	97%
601	Level Controller	Instrument Air	16	14	0.914	100%	193%

Facility SubType Code	Pneumatic Device Type	Driver	Facility SubType Count	Pneumatic Device Count	Average Pneumatic Count	95% Confidence Limit (% of mean)	
						lower	upper
601	Level Controller	Natural Gas	16	45	2.914	74%	113%
601	Positioner	Instrument Air	16	10	0.650	100%	282%
601	Positioner	Natural Gas	16	14	0.911	87%	123%
601	Pressure Controller	Instrument Air	16	6	0.398	100%	205%
601	Pressure Controller	Natural Gas	16	17	1.112	62%	81%
601	Pump	Instrument Air	16	6	0.389	100%	208%
601	Pump	Electric	16	1	0.065	100%	305%
601	Pump	Natural Gas	16	4	0.260	100%	170%
601	Transducer	Instrument Air	16	11	0.723	100%	302%
601	Transducer	Natural Gas	16	21	1.376	85%	132%
611	Intermittent	Instrument Air	4	4	1.045	100%	197%
611	Level Controller	Instrument Air	4	4	1.053	100%	194%
611	Pressure Controller	Instrument Air	4	3	0.781	100%	176%
611	Pump	Instrument Air	4	1	0.265	100%	274%
611	Transducer	Instrument Air	4	2	0.521	100%	283%
621	Intermittent	Instrument Air	34	20	0.610	75%	113%
621	Intermittent	Natural Gas	34	12	0.371	77%	112%
621	Level Controller	Instrument Air	34	80	2.457	61%	75%
621	Level Controller	Natural Gas	34	35	1.066	77%	110%
621	Positioner	Instrument Air	34	26	0.804	81%	109%
621	Positioner	Natural Gas	34	5	0.153	100%	252%
621	Pressure Controller	Instrument Air	34	31	0.958	68%	92%
621	Pressure Controller	Natural Gas	34	14	0.429	75%	99%
621	Pump	Instrument Air	34	1	0.030	100%	321%
621	Pump	Natural Gas	34	12	0.376	91%	147%

Facility SubType Code	Pneumatic Device Type	Driver	Facility SubType Count	Pneumatic Device Count	Average Pneumatic Count	95% Confidence Limit (% of mean)	
						lower	upper
621	Transducer	Instrument Air	34	47	1.443	85%	150%
621	Transducer	Natural Gas	34	13	0.396	100%	198%

Well Status Code	Pneumatic Device Type	Driver	Facility SubType Count	Pneumatic Device Count	Average Pneumatic Count	95% Confidence Limit (% of mean)	
						lower	upper
CBMOT FLOW	Intermittent	Natural Gas	21	5	0.250	100%	304%
CBMOT FLOW	Level Controller	Natural Gas	21	2	0.099	100%	200%
CBMOT FLOW	Positioner	Natural Gas	21	3	0.151	100%	297%
CBMOT FLOW	Pump	Natural Gas	21	2	0.099	100%	204%
CBMOT PUMP	Intermittent	Natural Gas	1	1	1.044	100%	151%
CBMOT PUMP	Pump	Natural Gas	1	1	1.053	100%	150%
CR-BIT PUMP	Intermittent	Natural Gas	85	3	0.037	100%	313%
CR-OIL FLOW	Intermittent	Natural Gas	21	3	0.148	100%	156%
CR-OIL FLOW	Level Controller	Instrument Air	21	3	0.14626	100%	308%
CR-OIL FLOW	Level Controller	Natural Gas	21	3	0.150	100%	214%
CR-OIL FLOW	Positioner	Instrument Air	21	7	0.34848	73%	87%
CR-OIL FLOW	Pressure Controller	Instrument Air	21	1	0.04943	100%	315%
CR-OIL FLOW	Pressure Controller	Natural Gas	21	2	0.098	100%	201%
CR-OIL FLOW	Pump	Electric	21	1	0.04996	100%	300%
CR-OIL FLOW	Pump	Instrument Air	21	3	0.15046	100%	301%
CR-OIL FLOW	Pump	Natural Gas	21	4	0.200	100%	168%
CR-OIL PUMP	Intermittent	Instrument Air	103	5	0.05097	100%	200%

Well Status Code	Pneumatic Device Type	Driver	Facility SubType Count	Pneumatic Device Count	Average Pneumatic Count	95% Confidence Limit (% of mean)	
						lower	upper
CR-OIL PUMP	Intermittent	Natural Gas	103	27	0.274	55%	67%
CR-OIL PUMP	Intermittent	Propane	103	5	0.05078	100%	245%
CR-OIL PUMP	Level Controller	Instrument Air	103	3	0.0305	100%	228%
CR-OIL PUMP	Level Controller	Natural Gas	103	24	0.243	61%	77%
CR-OIL PUMP	Level Controller	Propane	103	2	0.02051	100%	312%
CR-OIL PUMP	Pressure Controller	Instrument Air	103	3	0.03054	100%	223%
CR-OIL PUMP	Pressure Controller	Natural Gas	103	12	0.122	67%	96%
CR-OIL PUMP	Pump	Electric	103	2	0.02045	100%	205%
CR-OIL PUMP	Pump	Instrument Air	103	2	0.0202	100%	211%
CR-OIL PUMP	Pump	Natural Gas	103	25	0.253	57%	73%
CR-OIL PUMP	Transducer	Natural Gas	103	1	0.010	100%	320%
GAS FLOW	Intermittent	Instrument Air	127	26	0.21387	74%	161%
GAS FLOW	Intermittent	Natural Gas	127	57	0.468	43%	52%
GAS FLOW	Level Controller	Instrument Air	127	60	0.49545	47%	57%
GAS FLOW	Level Controller	Natural Gas	127	48	0.395	40%	47%
GAS FLOW	Positioner	Instrument Air	127	37	0.30528	46%	54%
GAS FLOW	Positioner	Natural Gas	127	10	0.082	67%	83%
GAS FLOW	Pressure Controller	Instrument Air	127	13	0.10714	59%	70%
GAS FLOW	Pressure Controller	Natural Gas	127	13	0.108	65%	85%
GAS FLOW	Pump	Instrument Air	127	51	0.41914	47%	52%
GAS FLOW	Pump	Natural Gas	127	44	0.362	41%	47%
GAS FLOW	Transducer	Instrument Air	127	51	0.42166	46%	55%
GAS FLOW	Transducer	Natural Gas	127	13	0.107	69%	88%
GAS PUMP	Intermittent	Natural Gas	62	31	0.522	44%	54%
GAS PUMP	Level Controller	Natural Gas	62	32	0.540	48%	54%

Table 8: Average (mean) pneumatic device counts and confidence intervals per well status.							
Well Status Code	Pneumatic Device Type	Driver	Facility SubType Count	Pneumatic Device Count	Average Pneumatic Count	95% Confidence Limit (% of mean)	
						lower	upper
GAS PUMP	Pressure Controller	Natural Gas	62	3	0.050	100%	165%
GAS PUMP	Pump	Instrument Air	62	1	0.01685	100%	312%
GAS PUMP	Pump	Natural Gas	62	38	0.639	42%	49%
GAS PUMP	Transducer	Instrument Air	62	3	0.05111	100%	307%
GAS PUMP	Transducer	Natural Gas	62	12	0.201	63%	79%
GAS STORG	Level Controller	Instrument Air	2	1	0.52634	100%	236%
GAS STORG	Positioner	Instrument Air	2	1	0.53481	100%	230%
GAS STORG	Pump	Electric	2	1	0.51649	100%	236%
GAS STORG	Transducer	Instrument Air	2	1	0.52853	100%	236%
SHG FLOW	Intermittent	Instrument Air	1	1	1.04159	100%	149%
SHG FLOW	Level Controller	Instrument Air	1	3	3.15243	100%	153%
SHG FLOW	Positioner	Instrument Air	1	3	3.10207	100%	152%
SHG FLOW	Pump	Instrument Air	1	1	1.0439	100%	153%

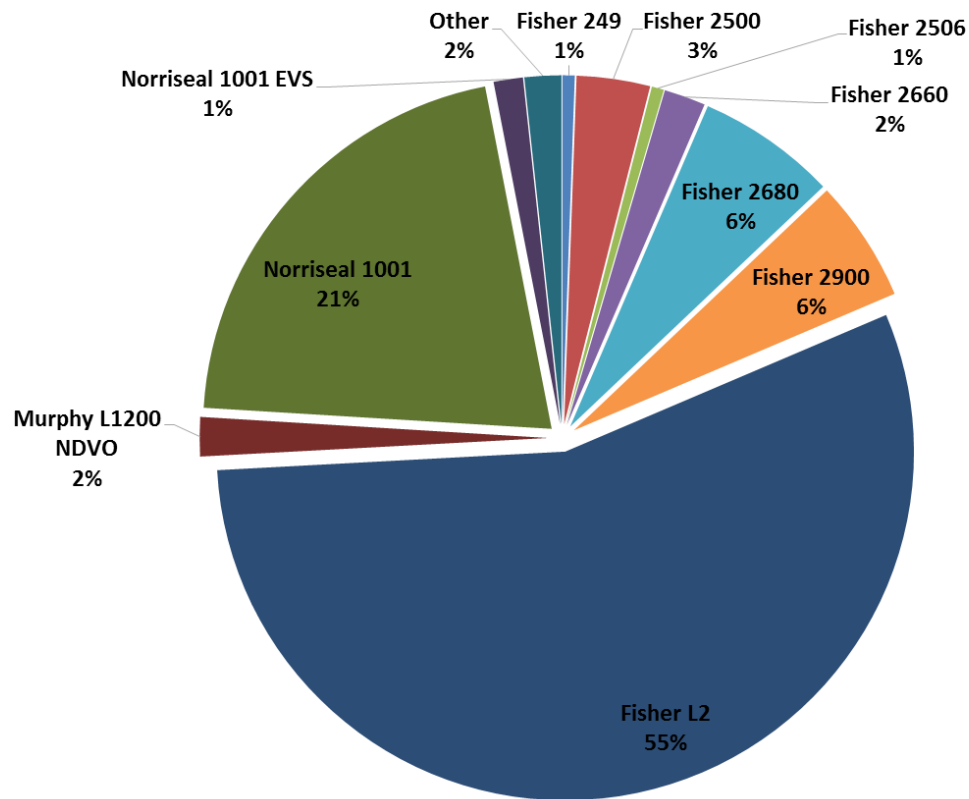

Figure 5: Distribution of level controller models observed during 2016 and 2017 surveys.

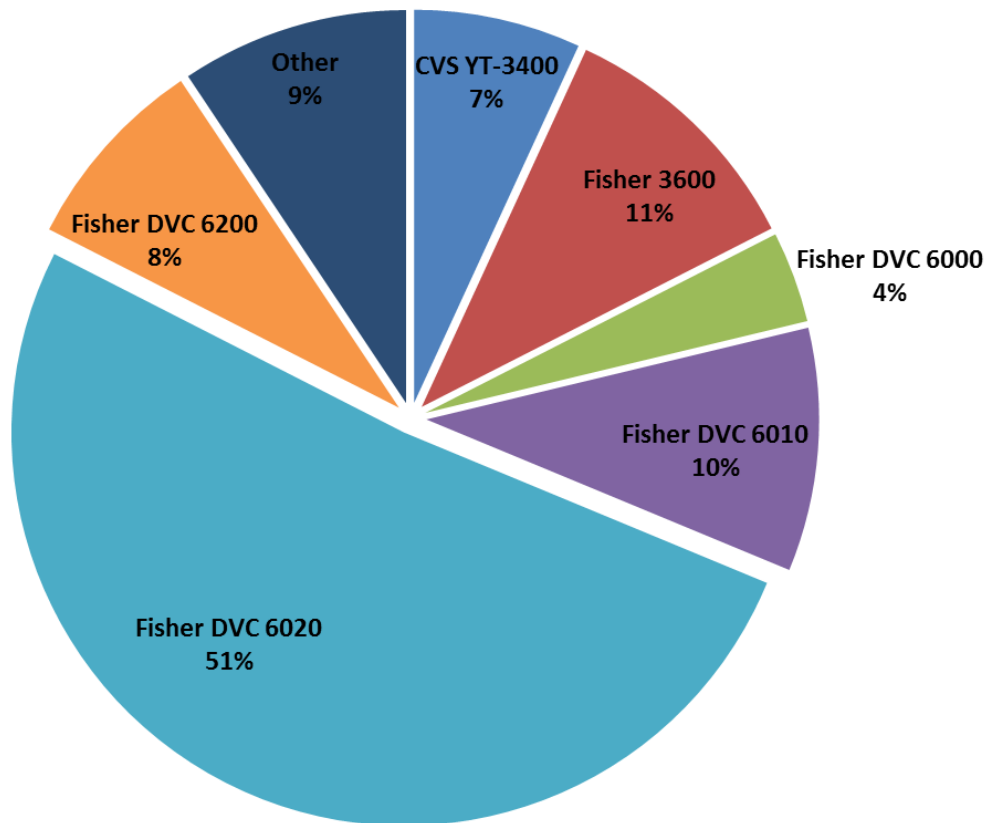

Figure 6: Distribution of positioner models observed during 2016 and 2017 surveys.

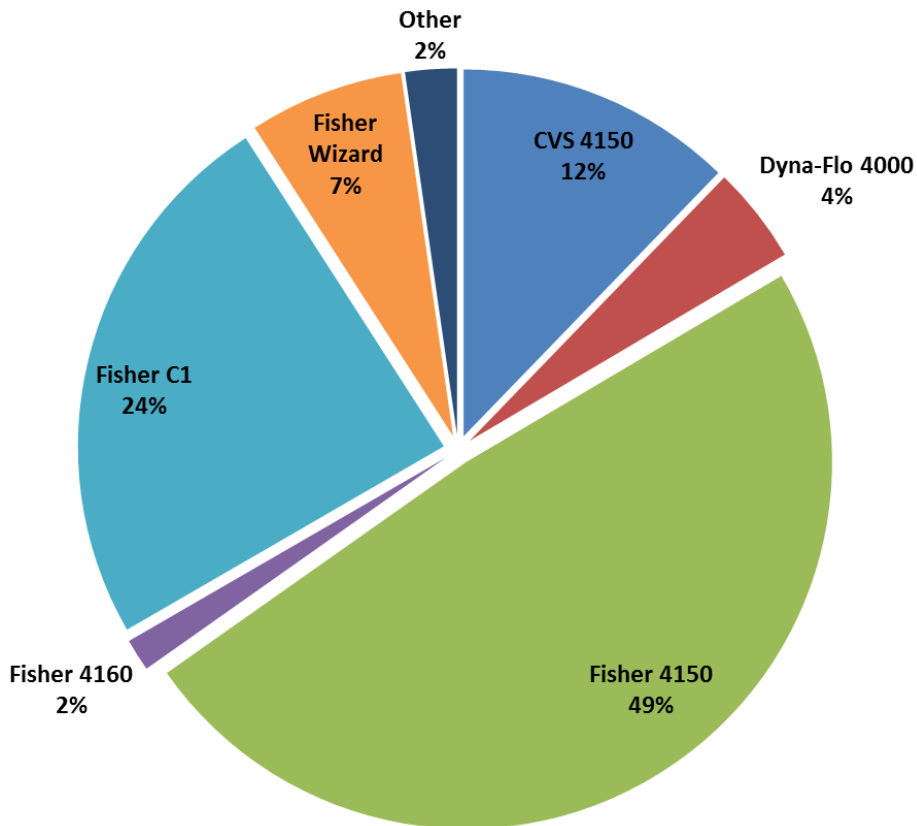

Figure 7: Distribution of pressure control models observed during 2016 and 2017 surveys.

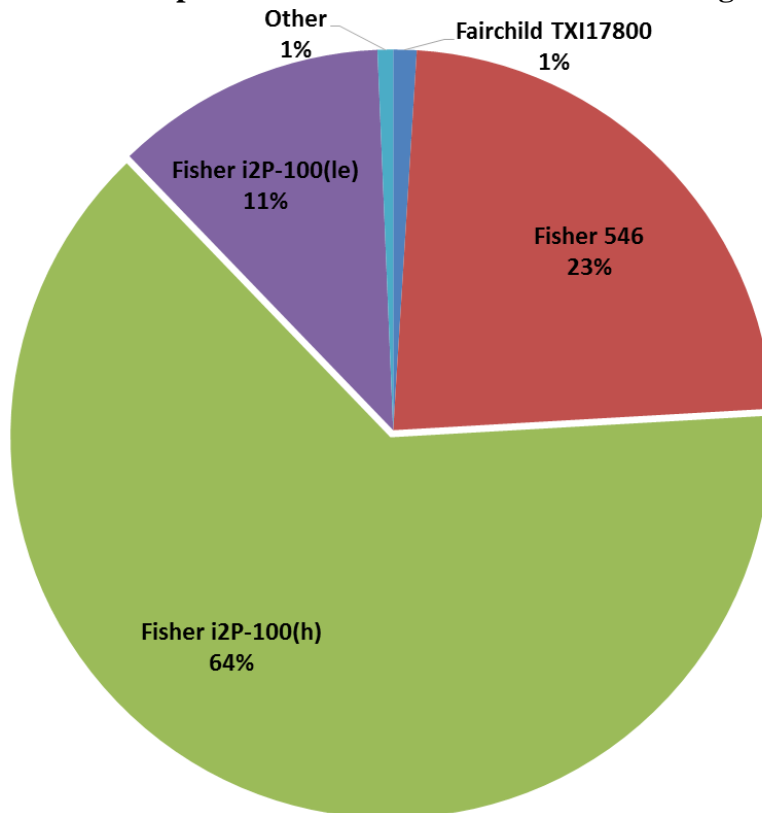

Figure 8: Distribution of transducer models observed during 2016 and 2017 surveys.

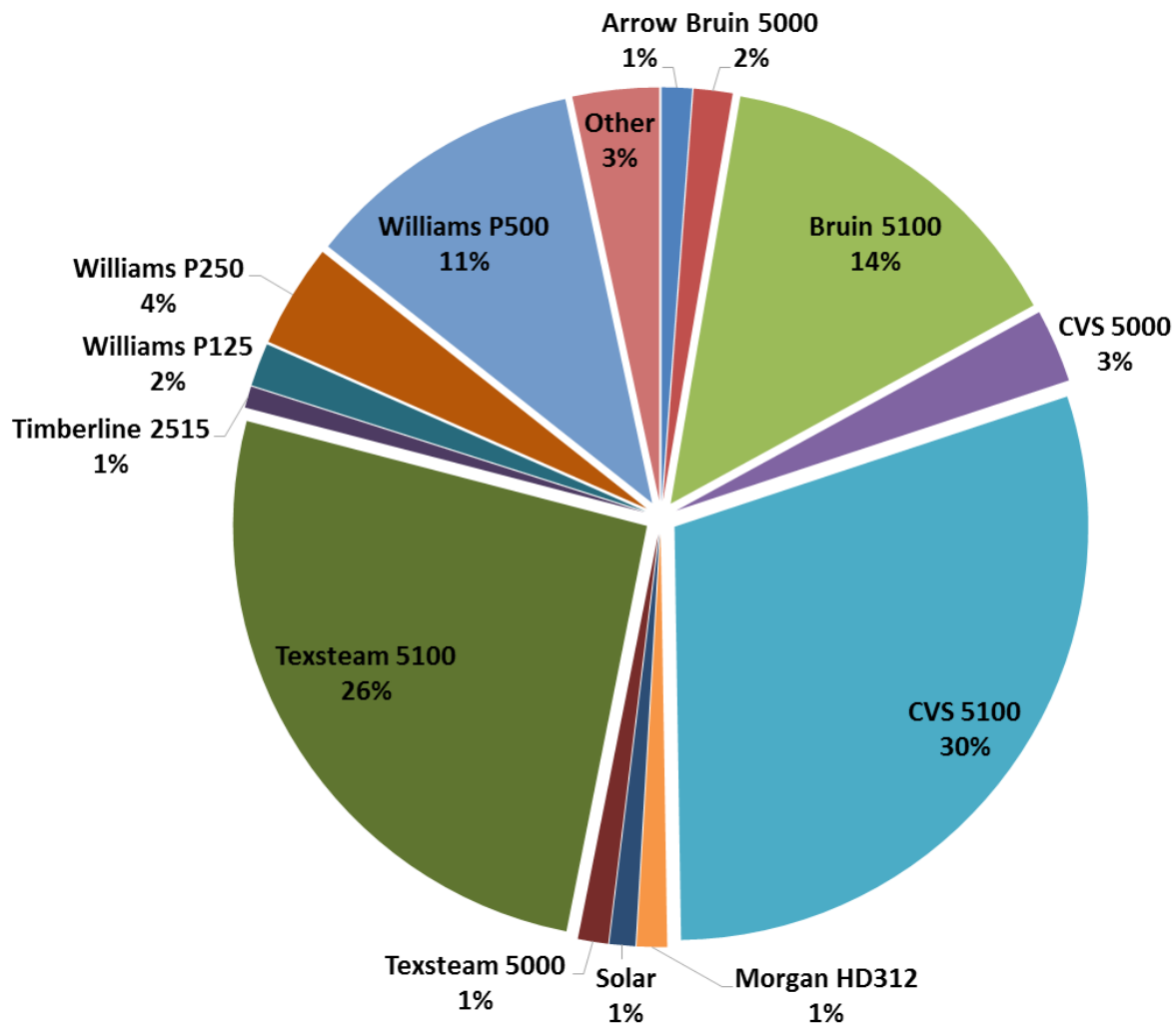

Figure 9: Distribution of chemical pump models observed during 2016 and 2017 surveys.

Figure 10 presents the distribution of pneumatic devices (pumps and instruments) allocated to Facility IDs (1072) by facility subtype and driver type. Figure 11 presents the distribution of pneumatic devices allocated to wells²³ (1789) by status code and driver type. Non-emitting instrument air and electric driven devices represent approximately 30 percent of the sample population with most of these (19 percent) located at facilities. Propane driven devices represent less than 1 percent of the entire sample population. Given the large number of wells and their tendency to rely on natural gas, well-site pneumatics are a noteworthy contributor to total methane emissions in Alberta and deserve careful consideration when developing province-wide emission inventories.

²³ Pneumatics dedicated to a well are assigned to the subject UWI and not the parent Facility ID. This has an upward bias on well average and downward bias on facility subtype averages.

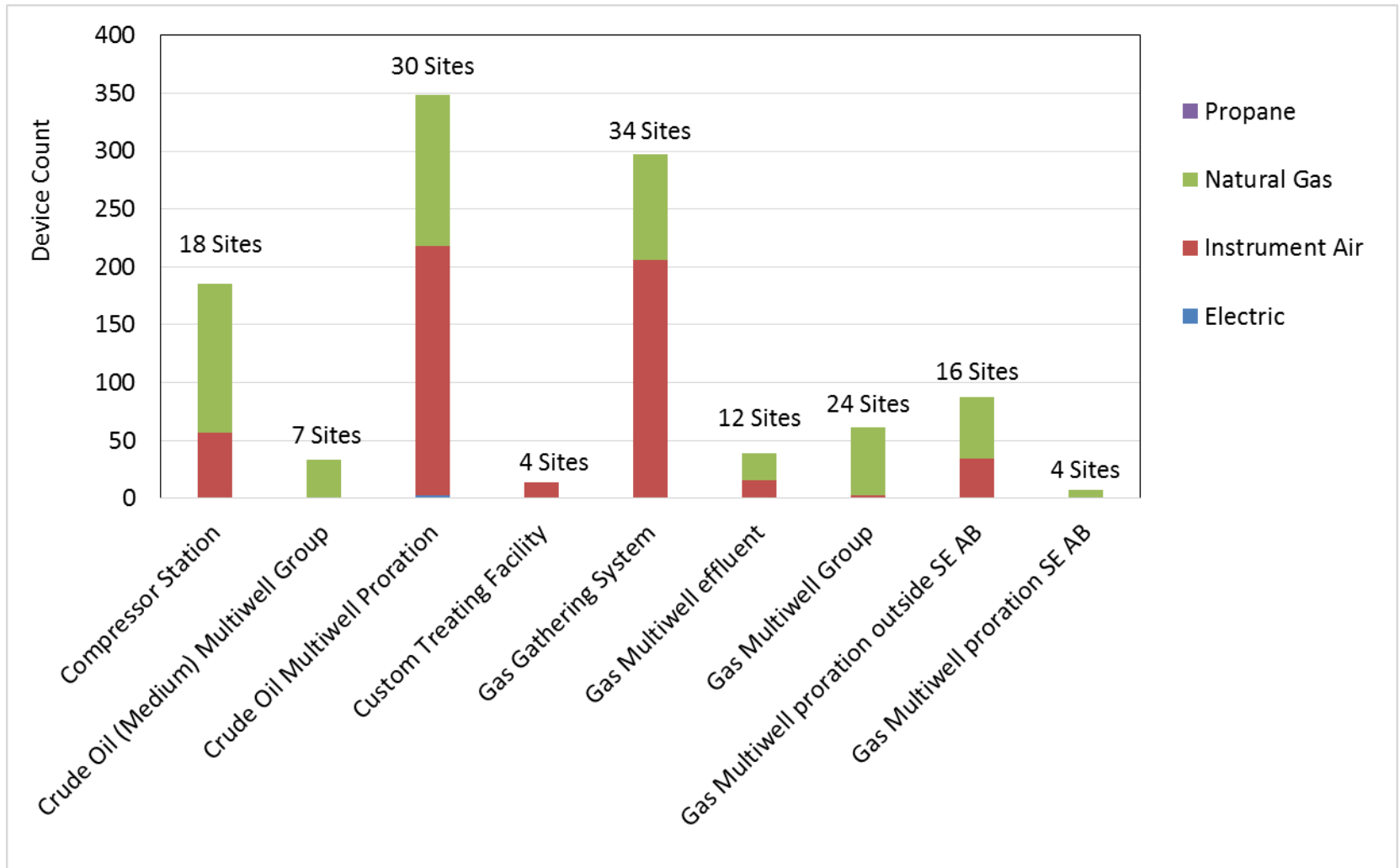

Figure 10: Pneumatic counts by facility subtype²⁴ (excluding locations where all devices are assigned to wells) and driver type.

²⁴ The number of sites surveyed for each subtype is stated at the top of each bar. Because the number of sites surveyed for each subtype is not proportional to Alberta-wide subtype populations, readers are cautioned that Figure 10 should not be interpreted as the actual distribution of pneumatics by subtype.

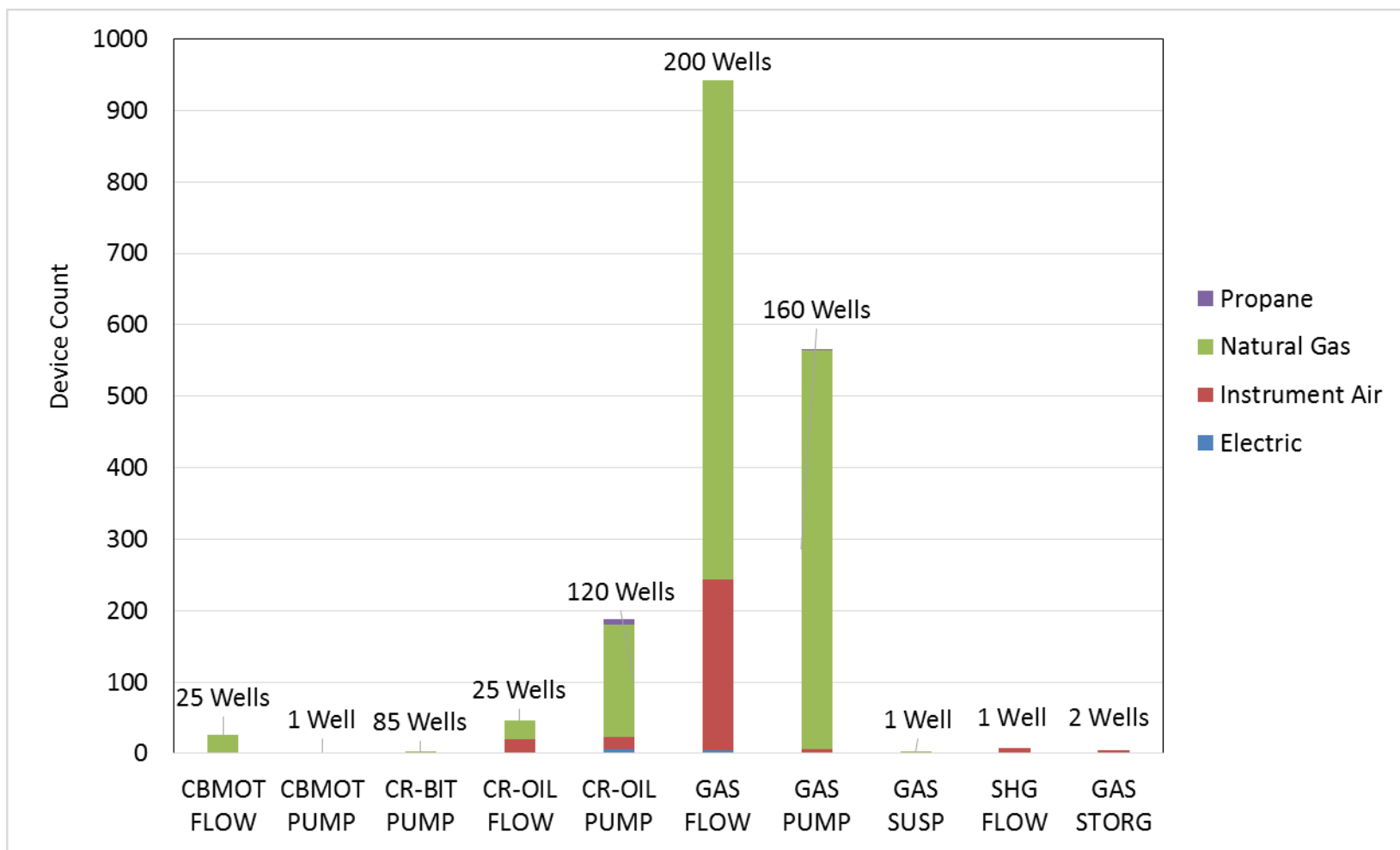

Figure 11: Pneumatic counts by well status code²⁵ and driver type.

²⁵ The number of wells surveyed for each status code (described in Table 2) is stated at the top of each bar. Because the number of wells surveyed is not proportional to Alberta-wide well status populations, readers are cautioned that Figure 11 should not be interpreted as the actual distribution of pneumatics by well status.

3.5 POPULATION AVERAGE LEAK FACTORS

Emission factors for estimating fugitive equipment leaks normally are evaluated by type of component and service category within an industry sector. This allows the factors to be broadly applied within the sector provided component populations are known. The advantage of this level of disaggregation is that it allows facility differences. A simpler approach which introduces additional uncertainties is to develop factors by type of process unit and area, or by type of facility; however, these higher-level factors are not considered here.

There are two basic types of emission factors that may be used to estimate emissions from fugitive equipment leaks: those that are applied to the results of leak detection or screening programs (e.g., leak/no-leak and stratified emission factors), and those that do not require any screening information and are simply applied to an inventory of the potential leak sources (i.e., population average emissions factors). Population average emission factors are considered in this section while ‘leaker’ emissions factors are determined in Section 3.6. ‘No-leak’ emission factors are not determined in this study because the Hi-Flow Sampler minimum detection limit (MDL) is not sensitive enough to accurately quantify leaks below 10,000 ppmv²⁶. No-leak factors for the Canadian UOG industry have received little research attention since the early 1990’s and available factors (from Table 7 of CAPP, 1992) may not be representative of current component populations. Instead of including no-leak contributions in the population average leak factor (as was the case for factors published in CAPP, 2014, CAPP, 2005 and CAPP, 1992), it’s recommended that these factors be applied separately when estimating fugitive emissions so their relative contributions are better understood and to facilitate inclusion of operator estimated fugitives²⁷ into emission inventories.

The population average emission factor for a given component and service category equals the total hydrocarbon emissions (that satisfy the leak definition presented in Section 8.1.1) divided by the number of potential leak sources (i.e., components) as presented in Equation 8. Unlike other studies that rely on typical component counts (CAPP, 2014 and EPA, 2016), emission factors are determined using component counts from the same sample population. Moreover, emission contribution from leaks below thresholds stated in Section 8.1.1 (i.e., no-leak factors) are not included in the population average.

Population average emission factors (mass and volumes rate) and their 95 percent confidence limits are presented in Table 9 and delineated by component type and service type. Further delineation by industry sector (i.e., factors for Oil versus Gas production sites) is considered in

²⁶ Ideally, no-leak emission factors would be developed using an instrument with precision of 1 ppm, MDL of about 2 ppm above background readings and measurement uncertainty of less than $\pm 1\%$ of reading.

²⁷ Pending methane regulations may require operators to report fugitive emissions estimated using leaker factors or by direct measurement. Both cases omit the no-leak contribution.

Section 10, however, one-way analysis of variance (ANOVA method) confirmed the difference in means between the “Gas” and “Oil” groups are not statistically significant.

The 95 percent confidence limits provide an indication of the variability of the compiled average emission factors. In general, the confidence interval is narrow when there are a large number of data points or the data is clustered around the mean. If the data shows a wide variability around the mean or there are few data points, the 95 percent confidence interval is wide. Comparing the confidence limits of two data sets provides a simple means of establishing if the data sets are from the same population (EPA, 1995).

$$PEF_{k,j} = \frac{\sum Q_{STPk,j} \text{ or } \sum \dot{m}_{k,j}}{\sum N_{k,j}}$$

Equation 9

Where,

- PEF_{i,k,j} = population average emission factor for service k and component type j (m³ or kg THC/hr/source),
- $\dot{m}_{i,k,j}$ = mass flow rate of total measured THC emissions for service k and component type j (kg THC/hr),
- Q_{STP,i,k,j} = volume flow rate of total measured THC emissions for service k and component type j at standard reference conditions (m³ THC/hr),
- N_{i,k,j} = total number of potential emission sources surveyed (i.e., total number of components including those that did not have any emissions) for service k and component type j (number).

Table 9: Population average emission factors for estimating fugitive emissions from Alberta UOG facilities on a volume or mass basis.

Sector	Component Type	Service	Leaker Count	Component Count	Leak Frequency	EF (kg THC /h/source)	95% Confidence Limit (% of mean)		EF (m ³ THC /h/source)	95% Confidence Limit (% of mean)	
							Lower	Upper		Lower	Upper
All	Compressor Rod-Packing ^{a,b}	PG		139		0.20622	53%	88%	0.28745	53%	88%
All	Connector	PG	145	137,391	0.11%	0.00014	32%	53%	0.00019	32%	52%
All	Connector	LL	6	45,356	0.01%	0.00001	71%	114%	0.00001	70%	120%
All	Control Valve	PG	16	539	2.97%	0.00487	53%	77%	0.00646	53%	77%
All	Meter	PG	8	531	1.51%	0.00105	47%	73%	0.00145	47%	70%
All	Open-Ended Line	PG	10	144	6.95%	0.06700	91%	219%	0.09249	91%	225%
All	Pressure Relief Valve	PG	7	1,176	0.60%	0.00399	54%	85%	0.00552	53%	79%
All	Pump Seal	PG	6	178	3.37%	0.00761	73%	142%	0.01057	73%	141%
All	Regulator	PG	27	3,067	0.88%	0.00112	60%	99%	0.00122	50%	76%
All	Thief Hatch	PG	6	52	11.46%	0.12870	77%	134%	0.12860	70%	115%
All	Valve	PG	28	20,545	0.14%	0.00044	64%	112%	0.00058	62%	111%
All	Valve	LL	6	8,944	0.07%	0.00015	72%	122%	0.00021	73%	120%
All	SCVF	PG	15	440	3.41%	0.09250	98%	204%	0.12784	98%	196%

^a Reciprocating compressor rod-packing emission factors are calculated on a per rod-packing basis and exclude compressors that are tied into a flare or VRU (because these rod-packings are controlled and have a very low probability of ever leaking to atmosphere). Rod-packings are defined as vents in Directive 060 (AER, 2018).

^b Reciprocating Compressor rod-packings vents are typically tied into a common header with measurements conducted on the common vent. Therefore, the actual number of leaking components and leak frequency are not known.

3.6 'LEAKER' FACTORS

To facilitate estimation of leaks detected but not measured during fugitive emission surveys, 'leaker' factors can be applied. 'Leaker' emission factors (mass and volumes rate) are calculated using Equation 10 and presented by component type and service type in Table 10 with their 95 percent confidence limits.

$$LEF_{k,j} = \frac{\sum Q_{STP_{k,j}} \text{ or } \sum \dot{m}_{k,j}}{\sum NL_{k,j}}$$

Equation 10

Where,

- $LEF_{i,k,j}$ = 'leaker' emission factor for service k and component type j (m^3 or kg THC/hr/leaking source),
- $\dot{m}_{i,k,j}$ = mass flow rate of total measured THC emissions for service k and component type j (kg THC/hr),
- $Q_{STP,i,k,j}$ = volume flow rate of total measured THC emissions for service k and component type j at standard reference conditions (m^3 THC/hr),
- $NL_{i,k,j}$ = number of leaking components detected for service k and component type j (number).

This screening-based approach for estimating fugitive emissions requires that a full leak detection survey be conducted and leaks (that satisfy the definition presented in Section 8.1.1) be recorded according to their service (process gas or light liquid) and component type (delineated in Section 8.3). End users can then multiply leak counts by the leaker factors in Table 10.

Fugitive emissions estimated using this approach should provide better accuracy and identification of high leak-risk components and facilities than population average factors. However, direct measurement of detected leaks is more accurate and provides valuable insight regarding leak magnitude and frequency distributions that are not available from emission factor approaches. For example, Figure 18 indicates that a small number of leaks contribute most of the fugitive emissions for a given component population. Screening coupled with direct measurement takes advantage of this fact to provide a reasonable balance between cost of assessment and accuracy of total estimated emissions.

Regardless of the estimation approach, the no-leak contribution representing leaks with a screening value of less than 10 000 ppmv or that are **not** observable with an IR camera should be estimated and included in emission inventories. This is accomplished by multiplying total component populations by no-leak emission factors (available from Table 18).

Table 10: Leaker emission factors for estimating fugitive emissions from Alberta UOG facilities on a volume or mass basis.

Sector	Component Type	Service	Leaker Count	Leaker EF (kg THC/h/source)	95% Confidence Limit (% of mean)		Leaker EF (m ³ THC/h/source)	95% Confidence Limit (% of mean)	
					Lower	Upper		Lower	Upper
All	Compressor Rod-Packing ^a	PG	27	1.08150	45%	58%	0.77563	43%	56%
All	Connector	PG	145	0.13281	19%	21%	0.10137	20%	21%
All	Connector	LL	6	0.05906	71%	88%	0.04156	70%	85%
All	Control Valve	PG	16	0.16213	47%	50%	0.12203	48%	52%
All	Meter	PG	8	0.07201	39%	49%	0.05238	40%	50%
All	Open-Ended Line	PG	10	0.98904	90%	195%	0.70729	90%	199%
All	Pressure Relief Valve	PG	7	0.69700	49%	62%	0.50395	49%	63%
All	Pump Seal	PG	6	0.23659	71%	121%	0.16974	71%	125%
All	Regulator	PG	27	0.10275	45%	56%	0.09514	56%	79%
All	Thief Hatch	PG	6	0.81672	67%	83%	0.82401	75%	106%
All	Valve	PG	28	0.31644	58%	90%	0.24356	60%	97%
All	Valve	LL	6	0.23098	72%	107%	0.16929	71%	110%
All	SCVF	PG	15	2.70351	97%	201%	3.74007	97%	189%

^a Because reciprocating compressor rod-packing leakage is routed to common vent lines, the actual number of leakers is not known. The compressor rod-packing 'leaker' factor is calculated on a per vent line basis (**not** per rod-packing basis). Rod-packings are defined as vents in Directive 060 (AER, 2018).

3.7 UNCERTAINTY ANALYSIS

It is good practice to evaluate the uncertainties in all measurement results and in the emission calculation parameters derived from these results. Quantification of these uncertainties ultimately facilitates the prioritization of efforts to improve the accuracy of emissions inventories developed using these data.

Measurement uncertainty arises from inaccuracy in the measuring equipment, random variation in the quantities measured and approximations in data-reduction relations. These individual uncertainties propagate through the data acquisition and reduction sequences, as described above, to yield a final uncertainty in the measurement result. Elemental uncertainty can arise from errors in calibration, data-acquisition, data-reduction, methodology or other sequences. Two types of uncertainties are encountered when measuring variables: systematic (or bias) and random (or precision) uncertainties (Wheeler and Ganji, 2004). Systematic and random errors are combined using IPCC Tier 1 rules for error propagation (described in Section 9) to determine confidence intervals for the factors presented above.

Random errors are characterized by their lack of repeatability during experimentation and can be described using probability density functions. The probability density function describes the range and relative likelihood of possible values. The shape of the probability density function may be determined empirically from the available measurement data. Confidence limits give the range within which the underlying value of an uncertain quantity is thought to lie for a specified probability. This range is called the confidence interval and is determined using the bootstrapping method described in Section 3.7.3. The IPCC (2000) Good Practice Guidance suggestion to use a 95% confidence level is adopted for this study (i.e., the interval that has a 95% probability of containing the unknown true value).

Systematic errors do not vary during repeated readings and are usually due to instrument properties or data reduction. The systematic uncertainties for measurement devices and gas analysis presented in Table 11 are considered when calculating leak rate uncertainties. Further discussion of uncertainties introduced by component count and leak detection methods are presented in Section 3.7.1 and 3.7.2.

Table 11: Parameter uncertainties according to measurement device or gas analysis source.			
Parameter	Measurement Device	Uncertainty	Reference
Atmospheric Pressure and Temperature	Multifunction digital thermometer and barometer	±10%	Professional judgement
Flow Rate	Anti-Static Measurement Bag	±10%	Heath, 2014
	Hawk PD Meter	±2%	Calscan, 2017

Table 11: Parameter uncertainties according to measurement device or gas analysis source.			
Parameter	Measurement Device	Uncertainty	Reference
	Hi-Flow Sampler	±10%	Bacharach, 2015
	Technician estimate from IR image	±100%	Professional judgement
Leak Detection	IR Camera	On average 3 of every 4 leaks are detected	Professional judgement and Ravikumar et al, 2018
Molecular Weight of Gas Mixture	Site specific gas analysis	±5%	Professional judgement
	Typical gas analysis	±25%	

3.7.1 COMPONENT COUNTING UNCERTAINTY

Of particular influence on overall confidence intervals is the uncertainty inherent to component and pneumatic device counting. Notwithstanding the desktop and field training described in Section 7.4, there is variability and bias introduced by field technicians when interpreting, classifying and counting the tremendous number of components in pressurized hydrocarbon service. To estimate the uncertainty introduced by field technicians, independent surveys were completed on different days by 2 different field teams of the same facility. Results from these surveys provide two overlapping sample counts for 8 distinct component types and 6 different pneumatic devices. Although the surveys covered a variety of equipment, the limited nature of two sample points per component and pneumatic device precludes an empirical estimation of the underlying distribution governing counting errors. Thus, a number of assumptions are required to estimate the uncertainty associated with the potential under or over counting of components and pneumatics. Individual component and pneumatic counts are combined into a single population of counting errors by computing the percent difference of each sample count from their respective sample mean. This normalization step creates a single sample set of 14 representative counting errors based on the assumption that inherent counting errors are independent of the component or pneumatic being counted (e.g. counting connectors carrying process gas is the same as counting connectors in liquid service, is the same as counting level controllers etc.). Under the assumption that these counting errors are normally distributed, the sample standard deviation σ_s could provide a simple point estimation for the spread of population of errors. However, because this survey data is limited in size and is from a single facility it's likely that because of sampling variability the uncertainty bounds defined by $\pm 2\sigma_s$ would not actually encompass 95% of the expected counting errors. To ensure the spread of the uncertainty bounds was sufficiently wide a tolerance interval was used.

A tolerance interval for capturing at least k% of the values in a normal population with a confidence level of 95% has the form $\pm(\text{tolerance critical value}) \cdot \sigma_s$ where the critical values

depend on the number of sample points and the desired value of k (typically chosen to be 90, 95, or 99). In the case of the survey data, choosing $k = 95$ results in a critical value of 3.012 and an overall estimate of the counting uncertainty for components and pneumatics was found to be $\pm 166\%$.

This random error for component and pneumatic device counts is incorporated into population average count and leak factor uncertainty using IPCC Tier 1 rules for error propagation.

3.7.2 OGI LEAK DETECTION UNCERTAINTY

Considering the recently published empirical correlation between leak rate, viewing distance and detection probability (Figure 3 in Ravikumar et al, 2018) and that most ground-level components are screened at a distance of 1 to 2 meters (Greenpath, 2017b); there is good probability that the IR camera MDL is about $0.015 \text{ m}^3 \text{ CH}_4/\text{hr}^{28}$ under favourable survey conditions (i.e., warm temperatures with wind speeds less than 4 m/s). However, survey conditions are not always ideal (e.g., wind gusts and rain) and screening distances increase for elevated components like compressor rod-packing vents (perhaps 3 to 6 meters away) and tank thief hatches (perhaps 5 to 20 meters away). Also, the capability and patience of technicians using the IR camera will vary and impact whether a leak is detected or not. Research, supported by the EPA, is underway at the Methane Emissions Test and Evaluation Center (METEC) in Colorado to develop empirical correlations for OGI performance factors (e.g., OGI equipment model, operator group and atmospheric conditions).

In the absence of defensible correlations, it is estimated that the IR camera on average detects 3 of every 4 leaks. Under the assumption that false positives (i.e. detecting a leak from a non-leaking component) do not occur, the actual number of component leaks at a site cannot be less than the leaks observed during an OGI survey. Consequently, the expected number of leaking components was modelled by scaling the observed leak counts by a leak count multiplier equal to $1+X$ where X is a random variable following a half-normal distribution with a mean of $1/3$. This systematic error is incorporated into the population average leak factor uncertainty using IPCC Tier 1 rules for error propagation.

3.7.3 BOOTSTRAPPING METHOD

Bootstrapping is a statistical resampling method which is typically used to estimate population variables/parameters from empirically sampled data (Efron, and Tibshirani, 1993). Bootstrapping as a method is non-parametric and does not rely on common assumptions such as normality, data symmetry or even knowledge of the data's underlying distribution. It is applied by other studies investigating 'heavy-tailed' leak distributions and is shown to increase the width of confidence

²⁸ This equals $10 \text{ g CH}_4/\text{hr}$ and is also the lowest measurement result obtained when using the High Flow Sampler during 2017. The manufacturer specification for the High Flow is $0.085 \text{ m}^3/\text{hr}$ and results below this MDL are possible but have greater uncertainty.

intervals by increasing the upper bound (Brandt et al, 2016). The one main underlying assumption behind bootstrapping, for the results to be reliable, is that the sample set is representative of the population.

In its most basic form bootstrapping is easily implemented to estimate the mean and the mean's associated confidence interval. For a sample set of size N, the samples are randomly resampled N-times with replacement to create a new set of observations of equal size. From this new resampled set a statistical parameter, in this case the mean, can be calculated. The procedure of resampling and re-computing a statistic from the original data is repeated over a large number of iterations (e.g. 10000 times) to obtain a distribution of bootstrapped estimates of the mean. An overall estimate and 95% confidence interval of the population mean is then extracted from the bootstrapped distribution.

The above bootstrapping process was directly applied to major equipment counts to obtain mean count estimates with a corresponding 95% confidence interval per well status or facility subtype. By virtue of the bootstrapping process the computed confidence intervals are not necessarily symmetric as would be the case under assumption that counts are normally distributed. For components, pneumatics, and flow rates the sample data was varied normally on each bootstrap resample according to specified counter and measurement device uncertainties.

For components, confidence interval estimates for a mean population leak factor were calculated by a Monte Carlo simulation. For each component type per service, where the leak data permitted, a population leak factor defined by:

$$\frac{\text{\# of component leaks}}{\text{\# of total components}} \cdot \text{Leak factor}$$

was computed 10000 times while randomly varying the number of component leaks as in Section 3.7.2 and varying the total number of components and the leak factor following their respective bootstrapped distributions. Similar to the bootstrapping process above, an overall estimate and 95% confidence interval of the population mean leak factor is then extracted from the resultant Monte Carlo distribution.

4 DISCUSSION

The intended application of average counts and factors as well as comparisons to other studies are discussed in the following sub-sections.

4.1 PROCESS EQUIPMENT

2017 field inventory results for facilities are discussed in Section 4.1.1 while well results are discussed in Section 4.1.2. A description of process equipment types is available in Section 8.4 while their use in emission inventories is discussed here.

Process equipment inventories are used to determine component populations and drive equipment leak emission calculations. Algorithms implemented for UOG national inventories (ECCC, 2014; CAPP, 2005 and CAPP, 1992) make decisions regarding the quantity and size of the following process equipment based on production data indicators.

- Natural gas fueled engines, turbines, heaters and boilers.
- Flares.
- Production storage tanks.

For example, if a flare volume is reported for a facility then a flare stack is added to the list of emission sources. The algorithm is more complicated for determining the type and size of natural gas fired equipment but the basic logic is the same: if natural gas fuel is reported, add combustion units to the list of emission sources. The average counts in Table 3 and Table 4 identify fired equipment types applicable to each facility subtype and well status code plus provide a ‘first guess’ regarding the number of units installed. The quantity of fired units at a specific site is adjusted according to the volume of natural gas fuel reported for the site versus theoretical fuel determined from reported production hours and typical power ratings.

However, other process equipment is difficult to estimate from production volumes or meta-data and historically relied on empirical knowledge of typical facility configurations (ECCC, 2014; CAPP, 2005 and CAPP, 1992). To acknowledge the uncertainty inherent with these predictions, a confidence interval of 100 percent was assigned to these process equipment units in the last national inventory. A better approach is to utilize the average process equipment counts for facility subtypes and well status codes presented in Table 3 and Table 4 that provide a statistically defensible basis for predicting equipment and includes equipment not identified in typical facility configurations.

4.1.1 FACILITIES

A comparison of average equipment counts applied to facility subtypes in the 2011 UOG national inventory versus those observed during 2017 field surveys is presented in Table 12 (when available). The total number of facility subtypes for each year is also presented as an indicator of the relative importance of a subtype to the Alberta UOG emission inventory. Of the 54 process equipment types anticipated to be in operation (delineated in Section 8.4), only half of these were observed during the 2017 surveys. Moreover, only the following 14 process equipment types were observed at a frequency greater than 1 in every 20 facilities visited. This is expected because of the tendency for standardized facilities and because little processing occurs upstream of gas plants and refineries. Thus, the simple equipment assignments made for the 2011 national inventory are reasonable. However, exceptions do occur and the average counts presented in Table 3 and Table 4 enable their quantification as well as improved delineation between facility subtypes and wells. For example, gas analysis systems are a source of continuous venting emissions and an H₂S analyzer was identified as the 3rd largest emitter observed by GreenPath Energy during 2016 inspections (Greenpath, 2017a), however, it's unknown how many analyzers are installed upstream of gas plants. Results from Table 3 indicate gas analyzers are installed at approximately 1 in every 17 compressor stations and at the same frequency for crude oil multiwell proration batteries while Table 4 shows gas analyzers installed at approximately 1 in 100 crude oil wells (pumping). Applying these factors to corresponding facility and well populations indicates there are about 400 gas analyzers installed upstream of gas plants in Alberta.

- Catalytic Heater
- Production Tank
- Separator
- Pipeline Header
- Pig Trap
- Reciprocating Compressor
- Screw Compressor
- Propane Fuel Tank
- Tank Heater
- Flare Knockout Drum
- Treater
- Dehydrator - Glycol
- Liquid Pump
- Pop Tank

Equipment at single-well batteries were assigned to UWIs (discussed in Section 4.1.2) so single-well batteries are not presented in Table 12. 2011 equipment counts are blank for bitumen

batteries and custom treating facilities because site-wide component counts were utilized in the 2011 inventory which precludes a direct comparison.

Dehydrators are not presented in Table 12 because, the AER Directive 039 inventory of glycol dehydrators (and emission control details) is relied on instead of the average counts presented in in Table 3. However, applying the average dehydrator counts to corresponding facility populations in Table 1 results in a prediction of 1,300 dehydrators operating at batteries, compressor stations and gathering systems. This is only 22 percent greater than listed for the same facility types in the 2016 AER dehydrator inventory (AER, 2017) which provides some confidence in provincial equipment populations predicted based on 2017 survey results.

2017 gas flow meter counts don't appear in Table 12 because they are defined as a component type (not an equipment type) for the 2017 survey with average leak rates presented in Section 3.5.

Table 12: Comparison of average equipment counts per facility subtype from the 2011 UOG national inventory (ECCC, 2014) versus those derived from 2017 field surveys.

Process Description	Ref Year	Compressor station	Crude bitumen multiwell group battery	Crude bitumen multiwell proration battery	Crude bitumen single-well battery	Crude oil (medium) multiwell group battery	Crude oil multiwell proration battery	Custom treating facility	Gas gathering system	Gas multiwell effluent battery	Gas multiwell group battery	Gas multiwell proration battery outside SE AB	Gas multiwell proration battery SE AB
Total Subtype Population	2011	773	861	461	3543	510	1711	50	2900	386	3634	760	941
	2017	760	1263	342	861	386	1720	41	2573	355	2548	691	412
Catalytic Heater	2011	0.88	0.73	0.68	0.48	0.57	0.72	0.22	0.50	0.63	0.60	0.48	0.14
	2017	2.69	0.50	0.08		1.31	4.12	0.25	2.04	2.08	0.48	3.26	0.45
Centrifugal Compressor	2011								0.39	0.30		0.15	0.03
	2017												
Gas Analysis System	2011												
	2017	0.06					0.06						
Gas Boot	2011												
	2017					0.10	0.06						
Gas Meter Building	2011		1.00	1.00	1.00	1.00				1.00	1.00		1.00
	2017							0.25	0.15				0.09
Gas Sweetening: Amine	2011						0.00				0.00		
	2017						0.03					0.10	
Incinerator	2011												
	2017					0.10							
LACT Unit	2011												
	2017							1.00					
Line Heater	2011								0.50	0.63	0.60	0.48	0.14
	2017					0.40	0.18						
Liquid Pump	2011												
	2017						0.33	0.75	0.03				
Pig Trap	2011					1.00			1.00				
	2017	0.31				0.20	0.69	0.25	0.44	0.58	0.24	0.50	
Pipeline Header	2011												
	2017	0.31	0.33	0.15		0.20	1.15		0.82	0.33	0.17	0.70	0.27

Table 12: Comparison of average equipment counts per facility subtype from the 2011 UOG national inventory (ECCC, 2014) versus those derived from 2017 field surveys.

Process Description	Ref Year	Compressor station	Crude bitumen multiwell group battery	Crude bitumen multiwell proration battery	Crude bitumen single-well battery	Crude oil (medium) multiwell group battery	Crude oil multiwell proration battery	Custom treating facility	Gas gathering system	Gas multiwell effluent battery	Gas multiwell group battery	Gas Multiwell proration battery outside SE AB	Gas multiwell proration battery SE AB
Pop Tank	2011		0.96	0.95	0.75	0.90	0.94			0.54	0.49	0.31	0.10
	2017	0.06				0.10	0.21	0.50			0.03		
Power Generator (natural gas fired)	2011												
	2017						0.03					0.10	
Process Boiler	2011												
	2017								0.03				
Production Tank	2011		1.93	0.53	1.18	1.50	1.32		0.16	0.84	0.80	0.52	0.12
	2017	0.19	1.07	1.54		1.29	2.57	3.51	0.32	0.41	0.28	0.30	
Propane Fuel Tank	2011												
	2017		0.08	2.76			0.06						
Reciprocating Compressor	2011	0.88	0.14	0.21	0.07	0.30	0.49		0.48	0.51	0.44	0.26	0.07
	2017	0.82					0.21		0.70	0.08	0.07	0.25	
Reciprocating Compressor - Electric Driver	2011												
	2017	0.06					0.09		0.18				
Screw Compressor	2011												
	2017	0.44	0.58	1.08		0.10	0.15		0.06			0.25	
Screw Compressor - Electric Driver	2011												
	2017						0.09	0.76	0.06				
Scrubber	2011												
	2017						0.03	0.50					
Separator	2011	1.03				1.00	0.01	1.00	1.01	1.01	1.02	1.00	1.01
	2017	0.75				0.70	2.46	0.50	0.88	0.83	0.21	0.65	0.27
Storage Bullet	2011												
	2017											0.10	

Table 12: Comparison of average equipment counts per facility subtype from the 2011 UOG national inventory (ECCC, 2014) versus those derived from 2017 field surveys.

Process Description	Ref Year	Compressor station	Crude bitumen multiwell group battery	Crude bitumen multiwell proration battery	Crude bitumen single-well battery	Crude oil (medium) multiwell group battery	Crude oil multiwell proration battery	Custom treating facility	Gas gathering system	Gas multiwell effluent battery	Gas multiwell group battery	Gas Multiwell proration battery outside SE AB	Gas multiwell proration battery SE AB
Tank Heater	2011		0.73	0.68	0.48	0.57	0.72	0.22					
	2017		0.76	1.54			0.03			0.17			
Treater	2011					1.00							
	2017						0.61	1.00					

4.1.2 WELLS

For wells, each active UWI was assigned a single wellhead in the 2011 UOG national inventory. The 2017 field survey results summarized in Table 13 indicate there are additional equipment units dedicated to servicing wells that should be included in emission inventories. Of particular note are multiwell batteries where the number of wells can vary from 2 to more than 1000. Applying the average counts for facilities from Table 3 doesn't adequately represent the variation in process equipment installed at a 2-well battery versus a 1000-well battery. Using well counts to drive process equipment predictions will result in more representative total populations.

Average wellhead counts less than one occur because of suspended wells where the main production valve is closed and downstream piping is depressurized. Shut-in wells are not included in the inventory because they are not a source of fugitive emissions. Using wellhead counts of less than one for emission inventories is reasonable because it's possible for a well to produce for only part of a reporting month, appear as an active well but in reality it was only a source of fugitive emissions for the period it was producing.

Table 13: Average well process equipment counts observed in 2017 versus 2011 UOG inventory counts.

Well Status Code	Well Description											
		Gas Analysis System (2017)	Gas Meter Building (2017)	Pig Trap (2017)	Pipeline Header (2017)	Pop Tank (2017)	Propane Fuel Tank (2017)	Scrubber (2017)	Separator (2017)	Well Pump (2017)	Wellhead (2011)	Wellhead (2017)
CBMCLS FLOW	Coalbed methane-coals only flowing			0.36							1.00	0.93
CBMOT FLOW	Coalbed methane-coals&oth lith flowing			0.05							1.00	1.00
CBMOT PUMP	Coalbed methane-coals&oth lith pumping			1.00							1.00	1.00
CR-BIT PUMP	Crude bitumen pumping				0.01		0.18			0.81	1.00	0.99
CR-OIL FLOW	Crude oil flowing								0.19	0.10	1.00	1.00
CR-OIL PUMP	Crude oil pumping	0.01		0.16	0.03	0.07	0.01	0.01	0.27	0.23	1.00	1.00
GAS FLOW	Gas flowing		0.06	0.07	0.04	0.01			0.45		1.00	1.00
GAS PUMP	Gas pumping			0.05	0.05		0.02		0.53		1.00	0.98
GAS STORG	Gas storage								0.50		1.00	1.00
SHG FLOW	Shale gas only flowing								1.00		1.00	1.00

4.2 COMPONENTS

A comparison between the component counts observed during the 2017 field study and those originally derived for the first Canadian UOG “bottom-up” national emission inventory (CAPP, 1992) is presented in Table 14. A simple ratio of the 2017 mean divided by the 1992 mean provides an indication of relative change in the average counts (nulls indicate zero components for one of the reference years). The historic components counts are based on bills of materials, drawings and actual field inspections of 100 process units (as described in Section 8, Volume 2 of CAPP, 1992). The 1992 report identifies field inspections as the most reliable method for determining average counts. The key advantages are the ability of inspectors to identify and account for components not illustrated on drawings (e.g., threaded connections); de-pressurized equipment; and exclude back-welded threaded connections (that have no pathway for leakage). The main disadvantages of field inspections are the time commitment and process knowledge required to identify and classify applicable components. Notwithstanding the inspector training efforts described in Section 7.4, large uncertainties are inherent to this approach and are a key contributor to confidence interval results presented in Table 5.

The number of components and type diversity per equipment type is greater for the 2017 data set. This is likely driven by increased process control and liquids-rich gas production introduced over the last 30 years as well as a specific field objective to account for every component in pressurized hydrocarbon service. When counting, inspectors included all process equipment components plus downstream components until they arrived at the inlet flange of the next process unit. This could include a significant number of components from ‘yard piping’ that are not physically attached to the process unit but are potential leak sources that need to be accounted. For example, the total average number of components for a separator increased 60 percent and now includes control valve, meter, open-ended line, PSV and regulator counts. These changes are reasonable when considering the 3-phase separator, shown in Figure 12, and commonly used at liquids-rich gas production sites. In addition to the control valve and senior orifice meter visible in Figure 12, this separator also features 1 junior orifice meter, 2 turbine meters, 4 regulators (heater and pneumatic pump fuel supply), 1 PSV, 2 chemical injection pumps and numerous pneumatic instruments.

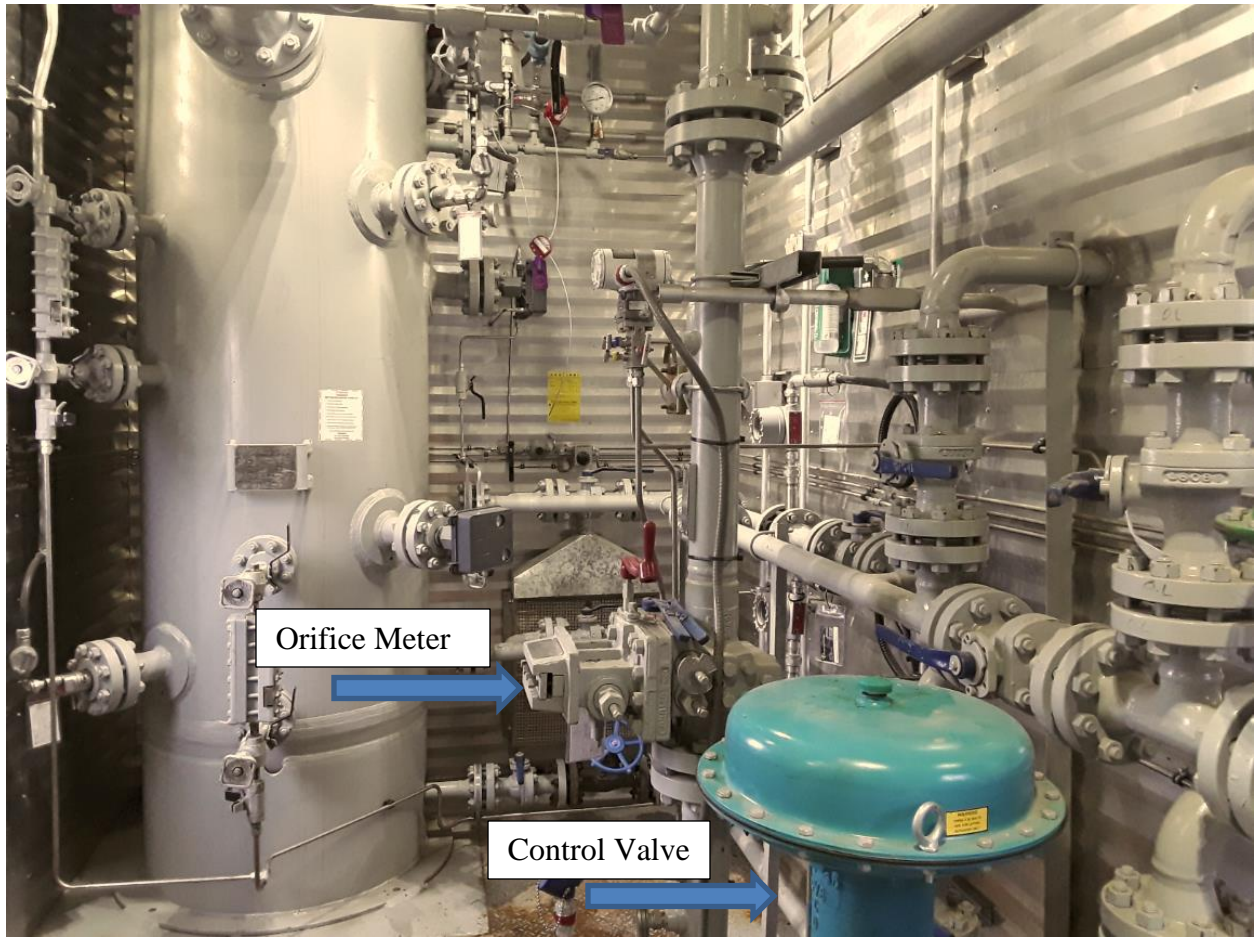

Figure 12: Three-Phase vertical separator located at a liquids-rich gas production site.

The 2017 field study also accounts for less common component installations. For example, a gas pressure regulator is not part of the typical design for an oil wellhead or included in 1992 wellhead component schedule. However, a regulator was observed in 2017 at the oil wellhead shown in Figure 13 and at 11 percent of all other oil wellheads. In the Figure 13 example, the regulator is part of the oil flow control system.



Figure 13: Example of a gas regulator installed on an oil wellhead.

Average component counts for the process equipment in Table 14 are summed according to service and component types and presented with confidence intervals in Figure 14 (less than 50 components per category) and Figure 15 (greater than 50 components per category). This view enables a comparison of 1992 and 2017 component inventories based on process equipment listed in Table 14. It indicates 2017 average counts are greater than 1992 average for all but 2 component categories (pump seals in light liquid service and open-ended lines in process gas service). Pump seal counts are lower in 2017 because there appears to be some redundancy in the 1992 counts for wellheads (Oil Pump), production tanks and pop tanks where the seal was counted once for the liquid pump and again for these equipment types. The decrease in open-ended lines may be due to improved leak mitigation efforts where the open side of sample or sensor port valves are typically fitted with a cap, plug or second closed block valve so they are no longer a potential leak source (and not inventoried as an open-ended line).

As indicated in Figure 14, the average number of PRVs, control valves and regulators has increased since 1992. The 1992 gas service PRV counts were limited to 9 of the 25 equipment types observed to feature pressure relief in 2017. These results suggest that the installation of pressure relief has proliferated since 1992. The other noteworthy observation is there are no regulators or control valves included in the original 1992 reference and only a limited number included in subsequent national inventories. Thus, these components appear to be under represented in historic inventories and the 2017 counts are a more reasonable basis for estimating fugitive emissions.

The 1992 reference does not present counts for thief hatches or meters so these are not included in the Figure 14 comparison.

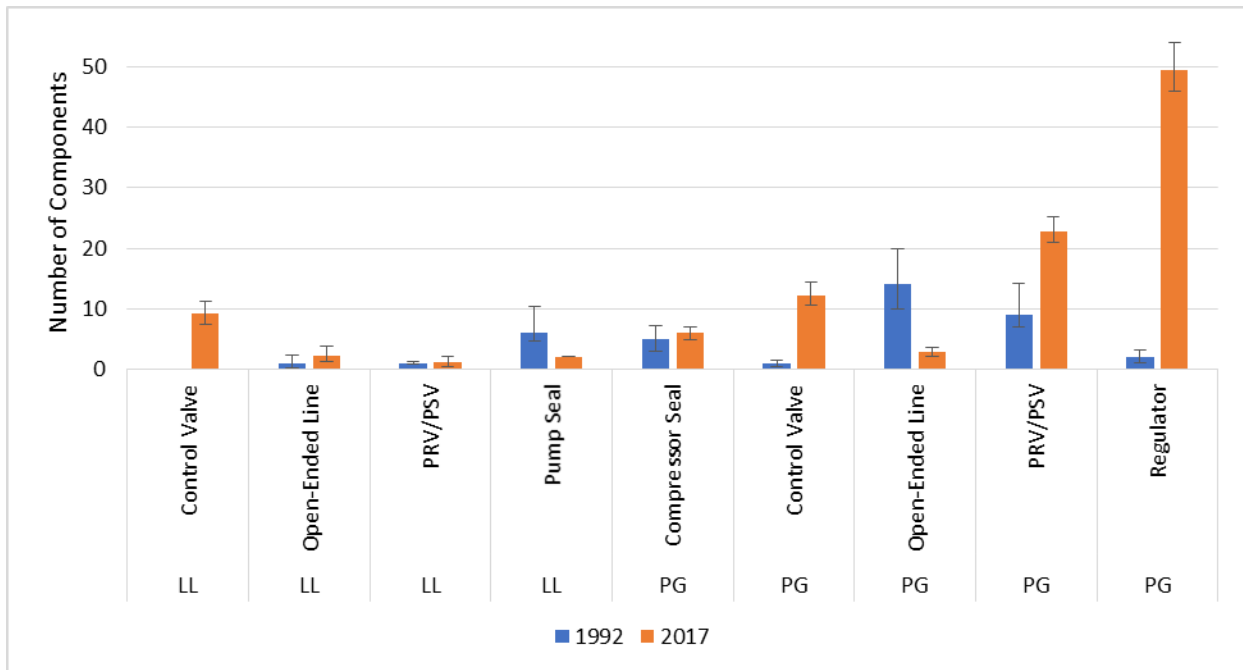

Figure 14: Comparison of 1992 and 2017 total number of components in light liquid (LL) and process gas (PG) service for the process equipment presented in Table 14 (component counts less than 50).

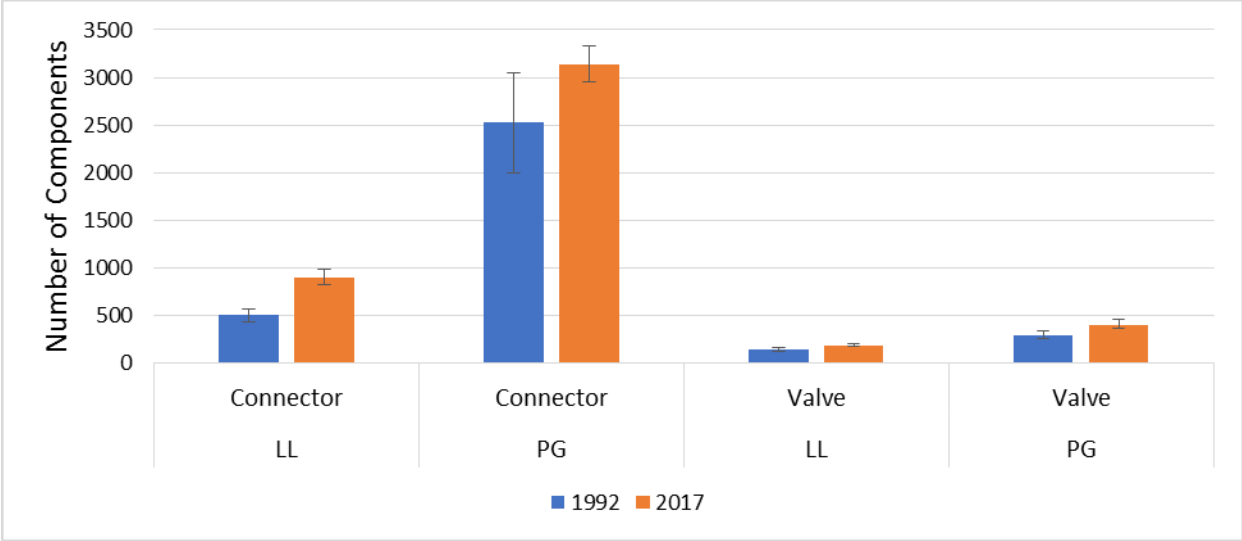

Figure 15: Comparison of 1992 and 2017 total number of connectors and valves in light liquid (LL) and process gas (PG) service for the process equipment presented in Table 14 (component counts greater than 50).

Table 14: Comparison of 2017 average (mean) component counts to values historically used for the UOG national emission inventory (CAPP, 1992).

Process Equipment Type	Component Type	Service Type	2017 mean	1992 mean	Ratio
Catalytic Heater	Connector	Process Gas	1.16	10	0.12
Catalytic Heater	Regulator	Process Gas	1.11		
Catalytic Heater	Valve	Process Gas	1.14	1	1.14
Dehydrator - Glycol	Connector	Light Liquid	11.31	14	0.81
Dehydrator - Glycol	Connector	Process Gas	206.75	100	2.07
Dehydrator - Glycol	Control Valve	Light Liquid	0.30		
Dehydrator - Glycol	Control Valve	Process Gas	1.25		
Dehydrator - Glycol	Meter	Process Gas	1.10		
Dehydrator - Glycol	Open-Ended Line	Process Gas	0.40		
Dehydrator - Glycol	PRV/PSV	Process Gas	2.49	1	2.49
Dehydrator - Glycol	Regulator	Process Gas	5.20		
Dehydrator - Glycol	Valve	Light Liquid	1.45	7	0.21
Dehydrator - Glycol	Valve	Process Gas	28.84	24	1.20
Flare KnockOut Drum	Connector	Light Liquid	18.28	20	0.91
Flare KnockOut Drum	Connector	Process Gas	52.21	26	2.01
Flare KnockOut Drum	Control Valve	Light Liquid	0.03		
Flare KnockOut Drum	Control Valve	Process Gas	0.17		
Flare KnockOut Drum	Meter	Process Gas	0.03		
Flare KnockOut Drum	Open-Ended Line	Light Liquid	0.65		
Flare KnockOut Drum	PRV/PSV	Process Gas	0.17		
Flare KnockOut Drum	Regulator	Process Gas	1.03		
Flare KnockOut Drum	Valve	Light Liquid	2.91	1	2.91
Flare KnockOut Drum	Valve	Process Gas	8.46	3	2.82
Gas Boot	Connector	Light Liquid	25.66	40	0.64
Gas Boot	Connector	Process Gas	5.00	37	0.14
Gas Boot	PRV/PSV	Process Gas	0.33		
Gas Boot	Valve	Light Liquid	6.67	2	3.33
Gas Boot	Valve	Process Gas	0.99	2	0.50
Gas Meter Building	Connector	Light Liquid	5.44		
Gas Meter Building	Connector	Process Gas	91.14	70	1.30
Gas Meter Building	Control Valve	Process Gas	0.50		
Gas Meter Building	Meter	Light Liquid	0.29		
Gas Meter Building	Meter	Process Gas	1.28		
Gas Meter Building	Open-Ended Line	Process Gas	0.14		
Gas Meter Building	PRV/PSV	Process Gas	1.07	2	0.54
Gas Meter Building	Regulator	Process Gas	1.58		
Gas Meter Building	Valve	Light Liquid	0.85		
Gas Meter Building	Valve	Process Gas	18.19	24	0.76
Gas Pipeline Header	Connector	Light Liquid	5.94		
Gas Pipeline Header	Connector	Process Gas	100.85	10	10.09

Table 14: Comparison of 2017 average (mean) component counts to values historically used for the UOG national emission inventory (CAPP, 1992).

Process Equipment Type	Component Type	Service Type	2017 mean	1992 mean	Ratio
Gas Pipeline Header	Control Valve	Process Gas	0.42		
Gas Pipeline Header	Meter	Process Gas	0.49		
Gas Pipeline Header	Open-Ended Line	Process Gas	0.06	1	0.06
Gas Pipeline Header	PRV/PSV	Process Gas	0.32		
Gas Pipeline Header	Regulator	Process Gas	0.73		
Gas Pipeline Header	Valve	Light Liquid	1.49		
Gas Pipeline Header	Valve	Process Gas	28.67	3	9.56
Gas Sweetening: Amine	Connector	Light Liquid	3.00	3	1.00
Gas Sweetening: Amine	Connector	Process Gas	84.42	702	0.12
Gas Sweetening: Amine	Open-Ended Line	Process Gas		3	
Gas Sweetening: Amine	PRV/PSV	Process Gas	0.67	2	0.34
Gas Sweetening: Amine	Pump Seal	Light Liquid		1	
Gas Sweetening: Amine	Regulator	Process Gas	1.00		
Gas Sweetening: Amine	Valve	Light Liquid	1.00	1	1.00
Gas Sweetening: Amine	Valve	Process Gas	35.38	60	0.59
Heavy Liquid Pipeline Header	Connector	Heavy Liquid	27.99		
Heavy Liquid Pipeline Header	Valve	Heavy Liquid	12.05		
Incinerator	Connector	Process Gas	53.00	10	5.30
Incinerator	Control Valve	Process Gas	2.00		
Incinerator	Regulator	Process Gas	3.00		
Incinerator	Valve	Process Gas	8.00	1	8.00
LACT Unit	Connector	Light Liquid	117.50		
LACT Unit	Connector	Process Gas	23.07		
LACT Unit	Control Valve	Light Liquid	2.50		
LACT Unit	Control Valve	Process Gas	0.75		
LACT Unit	Meter	Light Liquid	3.50		
LACT Unit	PRV/PSV	Light Liquid	0.50		
LACT Unit	PRV/PSV	Process Gas	0.50		
LACT Unit	Valve	Light Liquid	25.48		
LACT Unit	Valve	Process Gas	0.50		
Line Heater	Connector	Light Liquid	11.23		
Line Heater	Connector	Process Gas	98.60	185	0.53
Line Heater	Control Valve	Process Gas	0.27		
Line Heater	Meter	Process Gas	0.18		
Line Heater	PRV/PSV	Process Gas	0.63	1	0.63
Line Heater	Regulator	Process Gas	3.73		
Line Heater	Valve	Light Liquid	2.52		
Line Heater	Valve	Process Gas	11.56	20	0.58
Liquid Pipeline Header	Connector	Light Liquid	113.03	10	11.30
Liquid Pipeline Header	Control Valve	Light Liquid	0.42		

Table 14: Comparison of 2017 average (mean) component counts to values historically used for the UOG national emission inventory (CAPP, 1992).

Process Equipment Type	Component Type	Service Type	2017 mean	1992 mean	Ratio
Liquid Pipeline Header	Meter	Light Liquid	0.03		
Liquid Pipeline Header	Open-Ended Line	Process Gas		1	
Liquid Pipeline Header	Valve	Light Liquid	32.29	3	10.76
Liquid Pump	Connector	Light Liquid	58.47	10	5.85
Liquid Pump	Connector	Process Gas	4.27		
Liquid Pump	Meter	Light Liquid	0.43		
Liquid Pump	PRV/PSV	Light Liquid	0.57		
Liquid Pump	Pump Seal	Light Liquid	1.00	1	1.00
Liquid Pump	Valve	Light Liquid	14.51	3	4.84
Liquid Pump	Valve	Process Gas	0.65		
Pig Trap (Gas Service)	Connector	Process Gas	21.16	11	1.92
Pig Trap (Gas Service)	PRV/PSV	Process Gas	0.03		
Pig Trap (Gas Service)	Valve	Process Gas	7.76	3	2.59
Pig Trap (Liquid Service)	Connector	Light Liquid	16.38		
Pig Trap (Liquid Service)	Valve	Light Liquid	4.93		
Pop Tank	Connector	Light Liquid	5.50	24	0.23
Pop Tank	Connector	Process Gas	2.27		
Pop Tank	Open-Ended Line	Light Liquid	0.95		
Pop Tank	Pump Seal	Light Liquid		1	
Pop Tank	Valve	Light Liquid	1.25	10	0.12
Power Generator (natural gas fired)	Connector	Process Gas	101.26	74	1.37
Power Generator (natural gas fired)	Control Valve	Process Gas	0.66		
Power Generator (natural gas fired)	Regulator	Process Gas	3.00		
Power Generator (natural gas fired)	Valve	Process Gas	10.56	5	2.11
Process Boiler	Connector	Process Gas	64.00	25	2.56
Process Boiler	PRV/PSV	Process Gas	1.00		
Process Boiler	Regulator	Process Gas	4.00		
Process Boiler	Valve	Process Gas	15.00	2	7.50
Production Tank (fixed roof - heavy oil)	Connector	Heavy Liquid	36.19		
Production Tank (fixed roof - heavy oil)	Open-Ended Line	Heavy Liquid	0.02		
Production Tank (fixed roof - heavy oil)	PRV/PSV	Process Gas	0.02		
Production Tank (fixed roof - heavy oil)	Valve	Heavy Liquid	13.61		
Production Tank (fixed roof - Light/Medium Oil)	Connector	Light Liquid	20.86	24	0.87
Production Tank (fixed roof - Light/Medium Oil)	Connector	Process Gas	3.67	2	1.84
Production Tank (fixed roof - Light/Medium Oil)	Open-Ended Line	Light Liquid	0.01		
Production Tank (fixed roof - Light/Medium Oil)	Open-Ended Line	Process Gas	0.01		
Production Tank (fixed roof - Light/Medium Oil)	PRV/PSV	Process Gas	0.23		
Production Tank (fixed roof - Light/Medium Oil)	Pump Seal	Light Liquid		1	
Production Tank (fixed roof - Light/Medium Oil)	Regulator	Process Gas	0.23		
Production Tank (fixed roof - Light/Medium Oil)	Thief Hatch	Process Gas	0.62		
Production Tank (fixed roof - Light/Medium Oil)	Valve	Light Liquid	5.10	10	0.51
Production Tank (fixed roof - Light/Medium Oil)	Valve	Process Gas	0.41	1	0.41
Propane Fuel Tank	Connector	Process Gas	12.88		

Table 14: Comparison of 2017 average (mean) component counts to values historically used for the UOG national emission inventory (CAPP, 1992).

Process Equipment Type	Component Type	Service Type	2017 mean	1992 mean	Ratio
Propane Fuel Tank	Regulator	Process Gas	1.00		
Propane Fuel Tank	Valve	Process Gas	2.05		
Reciprocating Compressor	Compressor Seal	Process Gas	3.05	2	1.52
Reciprocating Compressor	Connector	Light Liquid	51.54	2	25.77
Reciprocating Compressor	Connector	Process Gas	585.21	420	1.39
Reciprocating Compressor	Control Valve	Light Liquid	0.67		
Reciprocating Compressor	Control Valve	Process Gas	2.04		
Reciprocating Compressor	Meter	Process Gas	0.28		
Reciprocating Compressor	Open-Ended Line	Process Gas	0.52	4	0.13
Reciprocating Compressor	PRV/PSV	Process Gas	3.51		
Reciprocating Compressor	Regulator	Process Gas	5.43		
Reciprocating Compressor	Valve	Light Liquid	6.06	1	6.06
Reciprocating Compressor	Valve	Process Gas	34.45	26	1.33
Reciprocating Compressor - Electric Driver	Compressor Seal	Process Gas	3.12	2	1.56
Reciprocating Compressor - Electric Driver	Connector	Light Liquid	55.85	2	27.93
Reciprocating Compressor - Electric Driver	Connector	Process Gas	392.85	275	1.43
Reciprocating Compressor - Electric Driver	Control Valve	Light Liquid	1.50		
Reciprocating Compressor - Electric Driver	Control Valve	Process Gas	0.30		
Reciprocating Compressor - Electric Driver	Meter	Process Gas	0.40		
Reciprocating Compressor - Electric Driver	Open-Ended Line	Process Gas		4	
Reciprocating Compressor - Electric Driver	PRV/PSV	Process Gas	2.30		
Reciprocating Compressor - Electric Driver	Regulator	Process Gas	0.10		
Reciprocating Compressor - Electric Driver	Valve	Light Liquid	8.89	1	8.89
Reciprocating Compressor - Electric Driver	Valve	Process Gas	17.51	20	0.88
Screw Compressor	Compressor Seal	Process Gas		1	
Screw Compressor	Connector	Light Liquid	33.91		
Screw Compressor	Connector	Process Gas	325.48	228	1.43
Screw Compressor	Control Valve	Light Liquid	0.15		
Screw Compressor	Control Valve	Process Gas	1.09	1	1.09
Screw Compressor	Meter	Process Gas	0.94		
Screw Compressor	Open-Ended Line	Process Gas	0.55		
Screw Compressor	PRV/PSV	Process Gas	3.26	2	1.63
Screw Compressor	Regulator	Process Gas	3.95	2	1.98
Screw Compressor	Valve	Light Liquid	4.36		
Screw Compressor	Valve	Process Gas	24.42	35	0.70
Screw Compressor - Electric Driver	Connector	Light Liquid	34.78		
Screw Compressor - Electric Driver	Connector	Process Gas	197.25		
Screw Compressor - Electric Driver	Control Valve	Process Gas	1.13		
Screw Compressor - Electric Driver	Meter	Process Gas	0.38		
Screw Compressor - Electric Driver	Open-Ended Line	Process Gas	0.25		
Screw Compressor - Electric Driver	PRV/PSV	Process Gas	1.50		
Screw Compressor - Electric Driver	Regulator	Process Gas	0.13		
Screw Compressor - Electric Driver	Valve	Light Liquid	3.38		

Table 14: Comparison of 2017 average (mean) component counts to values historically used for the UOG national emission inventory (CAPP, 1992).

Process Equipment Type	Component Type	Service Type	2017 mean	1992 mean	Ratio
Screw Compressor - Electric Driver	Valve	Process Gas	16.25		
Scrubber	Connector	Process Gas	71.80		
Scrubber	PRV/PSV	Process Gas	0.50		
Scrubber	Valve	Process Gas	11.46		
Separator	Connector	Light Liquid	65.12	41	1.59
Separator	Connector	Process Gas	103.93	66	1.57
Separator	Control Valve	Light Liquid	0.69		
Separator	Control Valve	Process Gas	0.85		
Separator	Meter	Light Liquid	0.40		
Separator	Meter	Process Gas	1.04		
Separator	Open-Ended Line	Process Gas	0.11		
Separator	PRV/PSV	Process Gas	1.60		
Separator	Regulator	Process Gas	2.39		
Separator	Valve	Light Liquid	11.83	11	1.08
Separator	Valve	Process Gas	19.26	11	1.75
Storage Bullet	Connector	Light Liquid	80.00	60	1.33
Storage Bullet	Connector	Process Gas		39	
Storage Bullet	Control Valve	Light Liquid	2.00		
Storage Bullet	PRV/PSV	Light Liquid		1	
Storage Bullet	PRV/PSV	Process Gas		1	
Storage Bullet	Valve	Light Liquid	20.00	27	0.74
Storage Bullet	Valve	Process Gas		15	
Tank Heater	Connector	Light Liquid		2	
Tank Heater	Connector	Process Gas	51.83	10	5.18
Tank Heater	Meter	Process Gas	0.02		
Tank Heater	Regulator	Process Gas	3.77		
Tank Heater	Valve	Process Gas	7.50	2	3.75
Treater	Connector	Light Liquid	90.96	56	1.62
Treater	Connector	Process Gas	189.36	178	1.06
Treater	Control Valve	Light Liquid	0.96		
Treater	Control Valve	Process Gas	0.75		
Treater	Meter	Light Liquid	0.46		
Treater	Meter	Process Gas	0.88		
Treater	Open-Ended Line	Light Liquid	0.59	1	0.59
Treater	Open-Ended Line	Process Gas	0.21	1	0.21
Treater	PRV/PSV	Process Gas	1.50		
Treater	Regulator	Process Gas	4.67		
Treater	Valve	Light Liquid	16.42	17	0.97
Treater	Valve	Process Gas	19.43	21	0.93
Well Pump	Connector	Light Liquid		57	

Table 14: Comparison of 2017 average (mean) component counts to values historically used for the UOG national emission inventory (CAPP, 1992).

Process Equipment Type	Component Type	Service Type	2017 mean	1992 mean	Ratio
Well Pump	Connector	Process Gas	48.83		
Well Pump	PRV/PSV	Process Gas	0.29		
Well Pump	Pump Seal	Light Liquid		1	
Well Pump	Regulator	Process Gas	1.95		
Well Pump	Valve	Light Liquid		14	
Well Pump	Valve	Process Gas	6.03		
Wellhead (Bitumen Pump)	Connector	Heavy Liquid	34.78	22	1.58
Wellhead (Bitumen Pump)	Connector	Process Gas	26.51		
Wellhead (Bitumen Pump)	Open-Ended Line	Process Gas	0.14		
Wellhead (Bitumen Pump)	PRV/PSV	Process Gas	0.28		
Wellhead (Bitumen Pump)	Regulator	Process Gas	0.45		
Wellhead (Bitumen Pump)	Valve	Heavy Liquid	8.59	9	0.95
Wellhead (Bitumen Pump)	Valve	Process Gas	7.24		
Wellhead (CBM Flow)	Connector	Process Gas	30.11	10	3.01
Wellhead (CBM Flow)	Meter	Process Gas	0.24		
Wellhead (CBM Flow)	Open-Ended Line	Process Gas	0.29		
Wellhead (CBM Flow)	PRV/PSV	Process Gas	0.06		
Wellhead (CBM Flow)	Regulator	Process Gas	0.06		
Wellhead (CBM Flow)	Valve	Process Gas	9.73	3	3.24
Wellhead (Gas Flow)	Connector	Light Liquid		1	
Wellhead (Gas Flow)	Connector	Process Gas	42.08	19	2.21
Wellhead (Gas Flow)	Meter	Process Gas	0.06		
Wellhead (Gas Flow)	Open-Ended Line	Process Gas	0.01		
Wellhead (Gas Flow)	PRV/PSV	Process Gas	0.05		
Wellhead (Gas Flow)	Regulator	Process Gas	0.39		
Wellhead (Gas Flow)	Valve	Process Gas	12.04	6	2.01
Wellhead (Gas Pump)	Connector	Process Gas	69.43		
Wellhead (Gas Pump)	Meter	Process Gas	0.32		
Wellhead (Gas Pump)	Open-Ended Line	Process Gas	0.03		
Wellhead (Gas Pump)	PRV/PSV	Process Gas	0.44		
Wellhead (Gas Pump)	Regulator	Process Gas	0.53		
Wellhead (Gas Pump)	Valve	Process Gas	13.79		
Wellhead (Gas Storage)	Connector	Light Liquid		1	
Wellhead (Gas Storage)	Connector	Process Gas	29.50	19	1.55
Wellhead (Gas Storage)	Valve	Process Gas	9.01	6	1.50
Wellhead (Oil Flow)	Connector	Light Liquid	29.66	57	0.52
Wellhead (Oil Flow)	Connector	Process Gas	34.06		
Wellhead (Oil Flow)	Meter	Process Gas	0.05		
Wellhead (Oil Flow)	Valve	Light Liquid	6.64	14	0.47
Wellhead (Oil Flow)	Valve	Process Gas	11.89		
Wellhead (Oil Pump)	Connector	Light Liquid	47.06	57	0.83

Table 14: Comparison of 2017 average (mean) component counts to values historically used for the UOG national emission inventory (CAPP, 1992).

Process Equipment Type	Component Type	Service Type	2017 mean	1992 mean	Ratio
Wellhead (Oil Pump)	Connector	Process Gas	17.40		
Wellhead (Oil Pump)	Meter	Process Gas	0.02		
Wellhead (Oil Pump)	Open-Ended Line	Process Gas	0.01		
Wellhead (Oil Pump)	PRV/PSV	Process Gas	0.04		
Wellhead (Oil Pump)	Pump Seal	Light Liquid	1.00	1	1.00
Wellhead (Oil Pump)	Regulator	Process Gas	0.11		
Wellhead (Oil Pump)	Valve	Light Liquid	9.61	14	0.69
Wellhead (Oil Pump)	Valve	Process Gas	3.73		

4.3 PNEUMATICS

The distribution of pneumatic instrument types (observed during 2016 and 2017 surveys) is presented in Figure 16 while the distribution between diaphragm, piston and electric (solar) styled pneumatic pumps is presented in Figure 17. Pneumatic instrument results, with intermittent bleed devices removed²⁹, are compared to pneumatic distributions presented in Figure 3 of Prasino, 2013 (derived from the Cap-Op DEEPP database containing about 2,000 pneumatic devices in 2013). As indicated in Table 15, the percent distribution of pressure controllers observed in 2016/17 is about 9 percent less than, while level controllers and positioners are 5 percent greater than, observed in the DEEPP database. Notwithstanding these small differences, there is general agreement in the distribution of instrument types used by the UOG industry between the independent data sets. Moreover, the average venting rate per generic pneumatic instrument determined from these two data sources are only about 4 percent different³⁰ which is less than the confidence interval of average venting rates presented in Table 16.

Table 15: Distribution of pneumatic instrument types observed in the 2016/17 inventory and DEEPP database.

Instrument Type	2016/17 Field Inventory	Prasino, 2013
Level Controller	44%	39%
Positioner	8%	3%
Pressure Controller	18%	27%
Transducer	15%	19%
Other	15%	12%

The 2016 and 2017 field inventories observed fewer piston type pneumatic pumps than presented in the Prasino study (i.e. Prasino Table 4 sample counts indicate an even distribution of piston and diaphragm types) whereas Figure 17 indicates diaphragm pumps are much more common. Consequently, there is less confidence in pump distributions and additional field studies may be merited.

²⁹ If not listed in Figure 3 of Prasino, 2013, intermittent bleed devices (e.g., CSV 7970 high-low pressure pilot) are removed from the 2016/17 data set to provide a common basis for comparison.

³⁰ Sample-size weighted averages were calculated by multiplying model specific counts by Prasino vent factors and dividing by total counts. The result equaled 0.2779 m³/hr for the 2016/17 data set versus 0.2664 m³/hr for the DEEPP database.

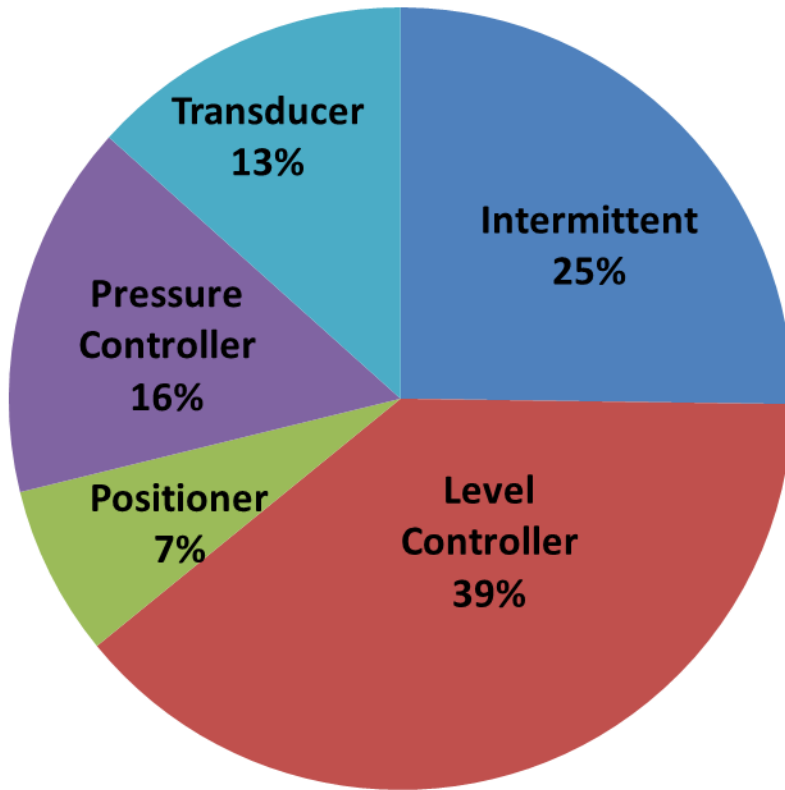

Figure 16: Distribution of pneumatic instrument types observed during 2016 and 2017 surveys.

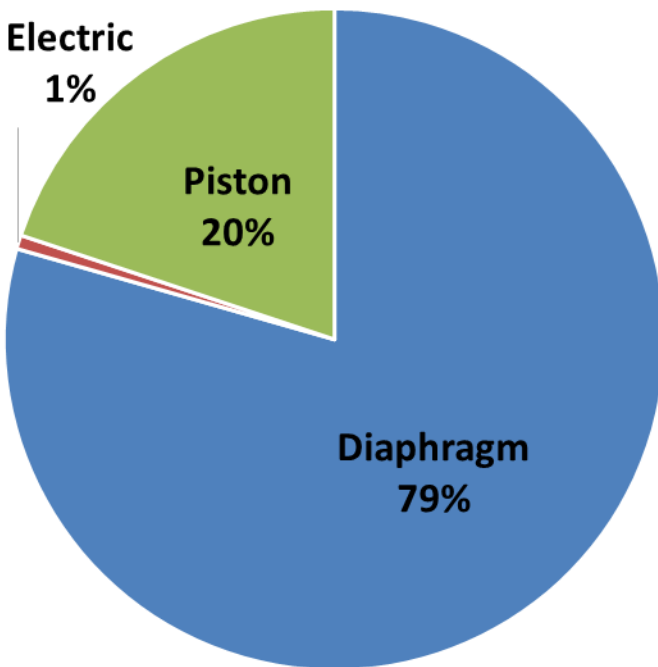

Figure 17: Distribution of chemical injection pump types observed during 2016 and 2017 surveys.

Because pneumatic venting rates were not measured during the 2017 and 2016 field campaigns, other studies are relied on to determine vent rates representative of each device type. Emission factors presented in Table 16 are a sample-size weighted average of mean bleed rates from 2013 Prasino and 2018 Spartan (Fisher L2 level controller³¹) studies as well as manufacturer specifications for less common models (Prasino, 2013 and Spartan, 2018). The factor labeled ‘generic pneumatic instrument’ includes high and low-bleed instruments that continuously vent. The ‘generic pneumatic instrument’ vent rate of 0.3217 m³/hr is greater than the ‘generic high bleed controller’ vent rate published in the Prasino study (0.2605 m³/hr) largely because of the revised level controller factor published by Spartan (i.e., 0.46 m³/hr ± 22% versus the Prasino factor of 0.2641 m³/hr ± 34%) and the large number of level controllers in the study population (indicated in Figure 16). Interestingly, the ‘generic pneumatic instrument’ vent rate is only 9 percent less than the rate applied in the last national inventory (i.e., 0.354 m³/hr in ECCC, 2014). The same isn’t true for chemical pumps, a rate of 0.236 m³/hr was applied in the last national inventory which is 4 times less than the rate presented in Table 16.

Table 16: Sample-size weighted average vent rates for pneumatic device types observed during 2016 and 2017 field campaigns.

Device Type	Average Vent Rate (m³ natural gas/hour)	95% Confidence Interval (% of mean)
Level Controller	0.3508	31.68
Positioner	0.2627	39.02
Pressure Controller	0.3217	35.95
Transducer	0.2335	22.54
Generic Pneumatic Instrument	0.3206	31.53
Chemical Pump	0.9726	13.99

4.4 POPULATION AVERAGE LEAK FACTORS

Leak factor results are based on best available OGI survey equipment and technicians currently providing fugitive emission services for the Canadian UOG industry. Notwithstanding this and QAQC efforts, the OGI leak detection and High Flow Sampler measurement methods have limitations that impact the completeness and accuracy of the subject dataset. Thus, a rigorous quantitative uncertainty analysis endeavors to identify and account for all parameters contributing uncertainty to the final emission factors. 2017 confidence limits are generally greater than historic values (presented in Table 18) primarily because of the following

31 Further investigation of level controllers was completed by Spartan (with the support of PTAC) because of concerns that the 2013 Prasino study did not adequately capture emission contributions from the transient state. The mean vent rate from Spartan (0.46 m³/hr ± 22% based on 72 samples) is used to determine level controller rate in Table 16 instead the Prasino factor (0.2641 m³/hr ± 34% based on 48 samples).

contributions that were acknowledged but underestimated in historic results (CAPP, 2005 and CAPP, 2014).

- Uncertainty in component counts due to field technician variability and bias (discussed in Section 3.7.1).
- Uncertainty that all leaks are detected by the OGI survey method (discussed in Section 3.7.2).

Exceptions where 2017 confidence limits are less than those presented in CAPP, 2014 occur for components with large no-leak contributions (e.g., connectors, PRV, pump seals and valves). The 2014 assessment assigned a very large upper confidence limit to no-leak factors (500 percent) which strongly influences population average confidence limits for components with large no-leak contributions. Whereas, no-leak contributions are not included in 2017 population average factors (and should be calculated as a separate category when estimating fugitive emissions).

Canadian UOG no-leak factors (from Table 7 of CAPP, 1992) are presented in Table 18 and combined with the 2017 sector-specific population average factors to facilitate an equivalent comparison with historic emission factors. The no-leak contribution to the combined emission factor is very small for compressor rod-packings, control valves, open-ended lines, pressure relief valves and pump seals. However, the no-leak contribution is greater than or approximately equal to the population average for connectors and valves (the components with the largest populations). Thus, 2017 combined leak factors are approximately the same as 2014 factors because they are both strongly influenced by the no-leak contribution. 2005 factors are greater than both 2017 and 2014 for all components (except SCVF) and therefore less influenced by the no-leak contribution.

Other noteworthy observations are discussed in the following subsections.

4.4.1 CONTRIBUTION OF FUGITIVE EMISSIONS NOT DETECTED BY THE IR CAMERA

Multiplying the total population of components screened in 2017 by corresponding no-leak factors equals 94 kg THC per hour while population average factors yields 149 kg THC per hour. Thus, the 1992 vintage no-leak factors are responsible for approximately 38 percent of the total estimated fugitives (for this component population). Considering the significant emission contribution of no-leak factors; the difficulty detecting very small leaks (less than 10,000 ppmv) with an IR Camera; the practicality of repairing very small leaks; and the federal regulatory focus on leak survey frequency, further field studies to validate no-leak factors and their actual contribution to total UOG fugitive emissions should be considered.

4.4.2 DISTRIBUTION OF 2017 LEAKS AND “SUPER-EMITTERS”

As indicated in Figure 18 below, the top 10 sites represent most (about 65 percent) of the total leak rate measured during the 2017 campaign with the single largest leak (a SCVF) representing 35 percent of the total leak rate. This is a highly skewed distribution with approximately 16 percent of the leaking components responsible for 80 percent of the total leak rate while the top 5 percent of leaking components are responsible for 64 percent of the total leak rate. This result is consistent with other studies and indicates “super-emitters” are present in the 2017 sample population. For example, a recent analysis of 15,000 leak measurements from 18 independent studies indicates leaks from natural gas systems follow extreme distributions with the largest 5 percent of leaks (“super-emitters”) contributing greater than 50 percent of the total leakage volume (Brandt et al, 2016). Skewed distributions are also observed in measurements completed in 2016 at sites near Red Deer, Alberta where high-emitting sites disproportionately account for the majority of emissions. This study indicates 20 percent of sites with highest emissions contribute 74 to 79 percent of the total emissions measured (Zavala-Araiza D. et al, 2018).

Table 18 provides some perspective on the relationship between facility production type and leak rate. It indicates that leak rates for 8 of the 11 component categories are greater at oil facilities than gas facilities. This is similar to observations at production sites near Red Deer, Alberta where oil producing sites tended to have higher emissions than sites without oil production (Zavala-Araiza D. et al, 2018).

4.4.3 COMPARISON OF 2017 RESULTS WITH HISTORIC FUGITIVE STUDIES

The 2017 PRV population average leak factor is much greater than the 2014 factor because very few PRV leaks were present in the 2014 dataset so the 2014 PRV factor is dominated by the no-leak contribution. The population average leak factors for regulators and control valves are similar to 2005 factors but much less than 2014 factors because default component populations³² used in CAPP, 2014 understate counts which has a strong upward bias on the emission factors. These component count limitations were discussed in CAPP, 2014 with recommendations to obtain actual field counts which motivated the current study.

The implications of new emission factors on total fugitive emissions is estimated in Table 17 and calculated by multiplying the 2017 component population (from Table 18) by population average leak factors from two other reference studies. However, the differences between 2017 and 2014 emission factors (described above) makes comparison of total fugitive emissions difficult. For example, the total number of regulators and control valves are understated in the CAPP, 2014 dataset so it doesn't matter that the corresponding emission factors are large (if using 2014 component populations). However, multiplying 2014 emission factors for regulators and control valves by corresponding 2017 component populations results in unreasonably large emission

³² Default component counts are based on inventories published in CAPP, 1992 and are compared to the 2017 counts in Table 14.

estimates. To mitigate this bias, 2014 THC emissions presented in Table 17 are calculated using 2017 analogues for regulator and control valve emission factors.

2017 and 2014 results in Table 17 are about the same and approximately 62 and 61 percent lower than fugitive emissions calculated using 2005 population average leak factors. This observation is similar to the CAPP, 2014 conclusion that fugitive equipment leaks have decreased 75 percent since publication of the CAPP BMP and implementation of DI&M programs.

Table 17: Comparison of fugitive emissions calculated using 2017, 2014 and 2005 population average leak factors and the same component population.					
	2017 (current study)			CAPP (2014)	CAPP (2005)
	Population Average EF	No-Leak EF (CAPP, 1992)	Total	Population Average plus No-Leak EF	Population Average plus No-Leak EF
Total THC Emissions (kg/hr)	149	94	243	245	634
% difference relative to 2005			-62%	-61%	

4.4.4 RECIPROCATING COMPRESSOR ROD-PACKING LEAKAGE RATES EXPECTED BY MANUFACTURERS

The largest manufacturer of reciprocating gas compressors indicates typical leakage rates for packing rings in good condition range from 0.17 m³ to 0.29 m³ per hour per rod-packing while the ‘alarm’ point for scheduling maintenance ranges from 2.9 m³ to 5.8 m³ per hour per rod-packing (Ariel, 2018). The probable population average leak rate for rod-packings presented in Table 9 is 0.2875 m³ THC per hour per rod-packing (with lower and upper confidence limits of 0.1361 and 0.5415 m³ THC per hour). Thus, reciprocating compressors surveyed in 2017 typically vent within manufacturer tolerances for packing rings in good condition. The upper confidence limit is much less than the maintenance alarm threshold of 2.9 m³ per hour. Only two measurement records were greater than 2.9 m³ per hour but because rod-packings vent into a common header, it’s not known whether the emissions were dominated by one or multiple rod-packings.

Efforts to determine the age of rod-packings and qualify observed emission rates were not successful because maintenance and replacement records were not available from operators or did not provide enough detail to determine rod-packing installation date.

It’s speculated that compressor rod-packing population average leak rates published in CAPP, 2014 are understated because of ambiguity in ‘leak’ versus ‘vent’ definitions. This study defines leakage from rod-packings as a leak but other programs define it as a vent (e.g., EPA, 2016 and

ECCC, 2014)³³. When “leak data” was provided by industry to complete the CAPP, 2014 emission factor analysis, rod-packing records may have been identified as “vents” by services providers and excluded from the 2014 dataset. Moreover, because 2014 input data was obtained from secondary sources, QAQC testing was limited to the input dataset and not the entire data management system. Thus it was difficult to detect this downward bias.

Similar ambiguity may apply to thief hatch and open-ended line components. Thus, communication of clear and concise definitions to field inspectors and end users is a critical part of fugitive emission assessments.

4.4.5 SCVF EMISSION FACTOR

The SCVF component is included in Table 18 to improve emission inventory transparency and highlight the significance of this source. The population average leak factor calculated from 15 leaks detected at 440 wells screened in 2017 is 0.0925 kg THC per hour which is only 37 percent less than the factor used to estimate SCVF emissions in the last UOG national inventory (ECCC, 2014). SCVF was the second largest source of methane released by the UOG industry because of the very large number of potential leak sources (i.e., approximately 150,000 wells in Alberta). The refined emission factor and confidence interval decreases SCVF contributions to total methane emissions and uncertainty, however, it is expected to remain one of the top 5 methane emission contributors.

4.4.6 COMPONENTS IN HEAVY LIQUID SERVICE

Also of note is that zero components in heavy liquid service were observed to be leaking. This is consistent with results presented in CAPP, 2014 and CAPP, 1992. Population average leak factors for components in heavy liquid service are presented in CAPP, 2005 but are at least one order of magnitude less than light liquid no-leak factors presented in Table 18. All four studies agree that components in heavy oil service have a very small contribution to total UOG fugitive emissions.

³³ Reciprocating compressor rod-packings in good condition are intended to release gas (i.e., a vent) but as they wear, the release rate increases and becomes a leak.

Table 18: Comparison of 2017 and historic population average leak factors (kg THC/h/source) for the Canadian UOG industry.															
Sector	Component Type	Service	CAPP (1992) No-Leak EF ^b	2017 Field Measurements			2017 Combined EF	CAPP (2014)			CAPP (2005)				
				EF	95% Confidence Limit (% of mean)			EF	95% Confidence Limit (% of mean)		EF Ratio (2017/2014)	EF	95% Confidence Limit (% of mean)		EF Ratio (2017/2005)
					Lower	Upper			Lower	Upper			Lower	Upper	
Gas	Compressor Rod-Packing ^c	PG	0.00175	0.16736	51%	87%	0.16882	0.04669	41%	44%	3.62	0.71300	36%	36%	0.24
Gas	Connector	PG	0.00061	0.00012	36%	57%	0.00073	0.00082	36%	250%	0.88	0.00082	32%	32%	0.88
Gas	Connector	LL ^a	0.00013	0.00001	71%	114%	0.00014	0.00016	54%	378%	0.86	0.00055	90%	111%	0.25
Gas	Control Valve	PG	0.00023	0.00301	68%	103%	0.00324	0.03992	44%	44%	0.08	0.01620	23%	23%	0.20
Gas	Meter	PG	0.00061	0.00149	52%	80%	0.00209	No emission factor			No emission factor				
Gas	Open-Ended Line	PG	0.00183	0.09630	95%	233%	0.09796	0.04663	42%	45%	2.10	0.46700	62%	161%	0.21
Gas	Pressure Relief Valve	PG ^a	0.00019	0.00399	54%	85%	0.00417	0.00019	55%	420%	21.97	0.01700	98%	98%	0.25
Gas	Pump Seal	PG	0.00023	0.00261	54%	82%	0.00284	0.00291	50%	367%	0.97	0.02320	74%	136%	0.12
Gas	Regulator	PG	0.00061	0.00077	52%	83%	0.00137	0.03844	45%	45%	0.04	0.00811	72%	238%	0.17
Gas	Valve	PG	0.00023	0.00062	66%	119%	0.00085	0.00057	38%	163%	1.50	0.00281	15%	15%	0.30
Gas	Valve	LL ^a	0.00081	0.00015	72%	122%	0.00096	0.00086	55%	442%	1.12	0.00352	19%	19%	0.27
Oil	Compressor Rod-Packing ^c	PG	0.00175	0.76120	92%	257%	0.76226	0.01474	60%	66%	51.71	0.80500	36%	36%	0.95
Oil	Connector	PG	0.00023	0.00019	37%	58%	0.00042	0.00057	27%	96%	0.74	0.00246	15%	15%	0.17
Oil	Connector	LL	0.00013	0.00001	71%	143%	0.00014	0.00013	36%	282%	1.05	0.00019	90%	111%	0.72
Oil	Control Valve	PG	0.00008	0.00962	66%	94%	0.00970	0.09063	87%	87%	0.11	0.01460	21%	21%	0.66
Oil	Meter	PG ^a	0.00061	0.00105	47%	73%	0.00165	No emission factor			No emission factor				
Oil	Open-Ended Line	PG ^a	0.00183	0.06700	91%	219%	0.06870	0.15692	47%	47%	0.44	0.30800	78%	129%	0.22
Oil	Pressure Relief Valve	PG	0.00019	0.00756	55%	87%	0.00775	0.00019	38%	313%	40.79	0.01630	80%	80%	0.48
Oil	Pump Seal	PG ^a	0.00023	0.00761	73%	142%	0.00783	0.00230	38%	294%	3.41	0.02320	74%	136%	0.34
Oil	Regulator	PG	0.00061	0.00154	79%	133%	0.00215	0.52829	38%	38%	0.00	0.00668	72%	238%	0.32
Oil	Thief Hatch	PG	0.00061	0.15852	77%	140%	0.15904	No emission factor			No emission factor				
Oil	Valve	PG	0.00008	0.00009	83%	158%	0.00017	0.00122	44%	48%	0.14	0.00151	79%	79%	0.11
Oil	Valve	LL	0.00058	0.00021	73%	125%	0.00079	0.00058	37%	288%	1.36	0.00121	19%	19%	0.65
All	SCVF	PG	0.00183	0.09250	98%	204%	0.09427	0.1464	Not Available		0.64	0.1464	Not Available		0.64

^a Insufficient sample size for 2017 to determine confidence limits for this sector, component and service type. Therefore, results presented for 2017 include samples from both oil and gas sectors.

^b No-leak factors are not available from CAPP, 1992 for Regulator, Meter, SCVF and Thief Hatch components so reasonable analogues are selected.

^c Reciprocating compressor rod-packing emission factors are calculated on a per rod-packing basis and exclude compressors that are tied into a flare or VRU (because these rod-packings are controlled and have a very low probability of ever leaking to atmosphere). Rod-packings are defined as vents in Directive 060 (AER, 2018).

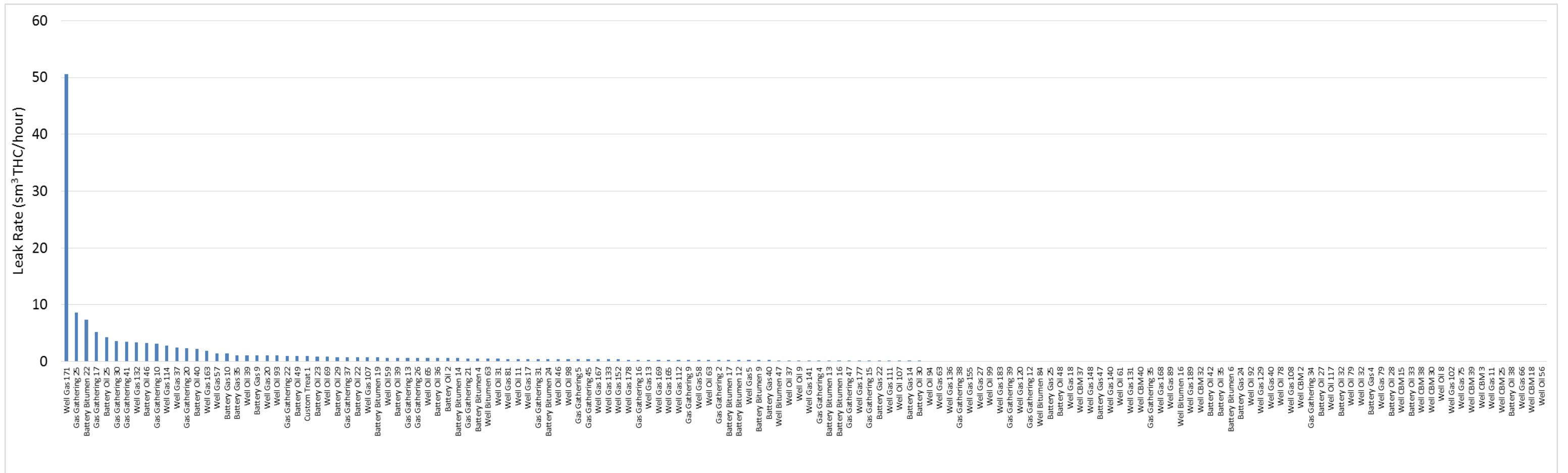

Figure 18: Distribution of total leak rate by site observed during the 2017 Alberta field campaign (excluding 195 sites where no leaks were detected).

4.5 LEAKER FACTOR

Canadian UOG 'leaker' factors (from Table 7 of CAPP, 1992) are compared to results from the current study in Table 19. The 'leaker' emission factors have increased relative to 1992 for connectors, open-ended lines and valves. However, leaker factors have decreased for all other components except for Control Valves, Meters, Regulators and Thief Hatches.

Sector	Component Type	Service	2017 Field Measurements				CAPP (1992)				EF Ratio (2017/1992)
			Leaker Count	EF	95% Confidence Limit (% of mean)		Leaker Count	EF	95% Confidence Limit (% of mean)		
					Lower	Upper			Lower	Upper	
Gas	Compressor Rod-Packing ^b	PG	20	0.74024	40%	49%	7	0.44	0.44	0.44	0.44
Gas	Connector	PG	88	0.08606	25%	29%	160	2.29	2.29	2.29	2.29
Gas	Connector	LL ^a	6	0.04156	70%	85%	6	1.11	1.11	1.11	1.11
Gas	Control Valve	PG	7	0.12230	66%	78%	No Emission Factor				
Gas	Meter	PG	7	0.05093	45%	57%	No Emission Factor				
Gas	Open-Ended Line	PG	9	0.73869	93%	209%	21	61.81	61.81	61.81	61.81
Gas	Pressure Relief Valve	PG ^a	7	0.50395	49%	63%	1	0.30	0.30	0.30	0.30
Gas	Pump Seal	PG	4	0.06177	49%	63%	1	0.14	0.14	0.14	0.14
Gas	Regulator	PG	17	0.05574	47%	62%	No Emission Factor				
Gas	Valve	PG	24	0.26767	64%	100%	101	1.02	1.02	1.02	1.02
Gas	Valve	LL ^a	6	0.16929	71%	110%	10	1.99	1.99	1.99	1.99
Oil	Compressor Rod-Packing ^b	PG	7	0.86950	83%	152%	7	0.51	0.51	0.51	0.51
Oil	Connector	PG	57	0.12545	27%	30%	37	3.35	3.35	3.35	3.35
Oil	Connector	LL	5	0.03443	71%	120%	6	0.92	0.92	0.92	0.92
Oil	Control Valve	PG	9	0.12150	62%	73%	No Emission Factor				
Oil	Meter	PG ^a	8	0.05238	40%	50%	No Emission Factor				
Oil	Open-Ended Line	PG ^a	10	0.70729	90%	199%	21	59.19	59.19	59.19	59.19
Oil	Pressure Relief Valve	PG	4	0.68355	49%	64%	1	0.40	0.40	0.40	0.40
Oil	Pump Seal	PG ^a	6	0.16974	71%	125%	1	0.39	0.39	0.39	0.39
Oil	Regulator	PG	10	0.16221	77%	113%	No Emission Factor				
Oil	Thief Hatch	PG	6	0.83178	75%	106%	No Emission Factor				
Oil	Valve	PG	4	0.11332	81%	153%	22	2.51	2.51	2.51	2.51
Oil	Valve	LL	5	0.19429	72%	106%	5	2.28	2.28	2.28	2.28

^a Insufficient 2017 sample size to determine confidence limits for this sector, component and service type. Therefore, results include samples from both oil and gas sectors.

^b Because compressor rod-packing leakage is routed to common vent lines, the actual number of leakers is not known. The compressor rod-packing ‘leaker’ factor is calculated on a per vent line basis (**not** per rod-packing basis). Rod-packings are defined as vents in Directive 060 (AER, 2018).

4.6 COMPARISON OF VENT AND LEAK EMISSION RATES

In addition to the inventories and leak measurements discussed above, field inspectors recorded venting emission sources observed with the IR camera at the 333 locations surveyed during 2017 and estimated their release magnitude (or measured the release if convenient to do so with the High Flow Sampler). Moreover, pneumatic venting is estimated using the average emission factors presented in Table 16. Although measurement of venting sources was not a primary objective for this study, available estimates for pneumatic and process vent sources enable a **qualitative** comparison with equipment leaks. Accordingly, the cumulative natural gas release rate is summed for all emission sources observed during the 2017 field campaign and presented by emission and source type in Figure 19. The largest contributors to equipment leaks are SCVF and reciprocating compressor rod-packings that represent approximately 60 percent of the total leak rate.

More importantly, the total leak rate is about 20 percent of the total natural gas released from all sources. Pneumatic devices (approximately 33 percent of the total release), production tanks (approximately 28 percent of the total release), heavy oil well casing vents (approximately 16 percent of the total release) and unlit flares (approximately 3 percent of the total release) are much more important sources natural gas emissions. A similar study of US natural gas production sites observed similar emission distributions where pneumatic and other venting sources contribute upwards of 70 percent while equipment leaks contribute approximately 13 percent of total methane emissions for the industry sector (Allen et al, 2013).

Although direct measurement of vent sources is often difficult to complete with the resources and equipment typically budgeted for leak surveys because of accessibility and process condition challenges (e.g., transient tank top emissions, dehydrator still columns or unlit flares). Qualitative indicators (e.g., the vent is small, large, or very large) may provide useful information to confirm production accounting completeness and improve the identification of cost-effective gas conservation opportunities. This approach may identify venting sources where the release magnitude is not fully appreciated by operators and represents the small number of sources that contribute the majority of methane emissions (discussed in Allen et al, 2013 and Zavala-Araiza D. et al, 2018). For example, a comparison with Petrinex records indicates that approximately 25 percent of Alberta locations observed to be venting in August or September 2017 did not report venting to Petrinex for the corresponding period (which represents about 25 percent of the estimated vent volume in Figure 19) (Petrinex, 2018). Of the 75 percent of locations where venting was observed and reported, the total Petrinex volume is approximately half of the volume estimated with the IR camera. Although the IR Camera estimates are qualitative and not sufficient for production accounting purposes; they can identify process venting sources, provide an indication of abnormal behaviour and trigger root-cause analysis when images indicate a risk of exceeding regulated site venting limits.

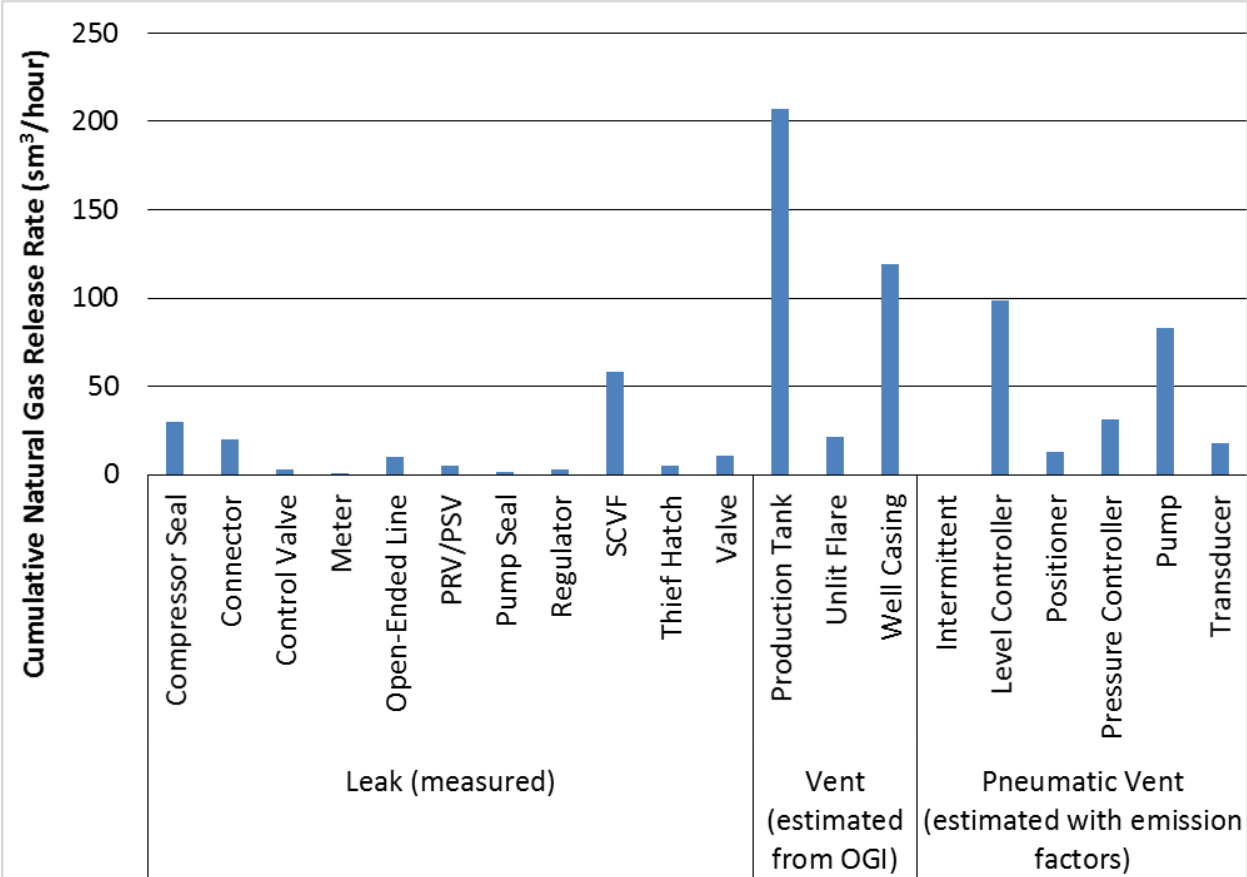

Figure 19: Cumulative hourly release rate for emission and source types observed at 333 locations during the 2017 Alberta field campaign.³⁴

³⁴ The venting estimates presented in **Error! Reference source not found.** have large, undetermined uncertainties and only provide a qualitative perspective on natural gas emission sources. Moreover, pneumatic results assume only half of the inventoried chemical pumps are active because many methanol injections pumps are only active during cold winter months. Also, in addition to flashing, breathing and working losses; production tank emissions may include contributions from well casing vents, leaks past liquid dump valves, unintentional gas flow-through from undersized separators.

5 CONCLUSIONS AND RECOMMENDATIONS

The following are key conclusions from the assessment of 2017 field equipment and leak measurement data.

- The following factors should be considered for Alberta UOG emission inventories subject to the utilization recommendations presented in Section 5.1.
 - Process equipment count per facility subtype or well status code.
 - Component count per process equipment unit.
 - Emission control type per process equipment unit.
 - Pneumatic device count per facility subtype or well status code by device and driver type.
 - Leak rate per component and service type considering the entire component population surveyed (i.e., ‘population average’ factor).
 - Leak rate per component and service type considering leaking components only (i.e., ‘leaker’ factor).

- The use of average factors determined in this report is a statistical approach which is only valid when estimating total emissions from a large number of sources. Results for individual facilities or process units may easily be in error by several orders of magnitude or more. However, considering the IPCC Tier 1 rules for error propagation (described in Section 9), the percentage uncertainty in the aggregate emission estimate for a category will tend to decrease by a factor of $1/N^{0.5}$ where N is the number of sources in that category. Thus, aggregate emission estimates become more representative as the number of sources and facilities increases.

- The impact of new emission factors on total fugitive emissions is estimated by multiplying 2017 component populations by population average leak factors from 2017, 2014 and 2005 reference studies. After mitigating bias in the 2014 emission factors, 2017 and 2014 results are observed to be about the same and approximately 62 and 61 percent lower than fugitive emissions calculated using 2005 population average leak factors. This observation is similar to the CAPP, 2014 conclusion that fugitive equipment leaks have decreased 75 percent since publication of the CAPP BMP and implementation of DI&M programs. However, further analysis based on larger component populations is recommended before broad conclusions regarding the net impact on Alberta methane emissions are relied upon.

- Considering that no-leak factors contribute 38 percent of the total THC fugitives emissions calculated for the 2017 component population³⁵; the difficulty detecting very small leaks (less than 10,000 ppmv) with an IR Camera; the practicality of repairing very small leaks and the federal regulatory focus on leak survey frequency, further field studies to validate no-leak factors and their actual contribution to total UOG fugitive emissions should be considered.
- The SCVF component is included in Table 18 to improve emission inventory transparency and highlight the significance of this source. The population average leak factor calculated from 15 leaks detected at 440 wells screened in 2017 is 0.0925 kg THC per hour which is only 37 percent less than the factor used to estimate SCVF emissions. SCVF was the second largest source of methane in the last UOG national inventory (ECCC, 2014) due to the very large number of potential leak sources (i.e., approximately 150,000 wells in Alberta). Given that the 2017 factor is only 37 percent less than the factor used in the last inventory, SCVF is expected to remain one of the top 5 contributors of methane in subsequent emission inventories.
- Equipment leaks are estimated to be less than 20 percent of total natural gas fugitive and venting emissions observed during the 2017 field campaign. Pneumatic devices (approximately 40 percent of the total release), production tanks (approximately 25 percent of the total release), heavy oil well casing vents (approximately 14 percent of the total release) and unlit flares (approximately 3 percent of the total release) are arguably much more important sources of natural gas emissions.
- Although direct measurement of vent sources is often difficult to complete with the resources and equipment typically budgeted for leak surveys because of accessibility and process condition challenges (e.g., transient tank top emissions, dehydrator still columns or unlit flares). Qualitative indicators obtained with an IR camera (e.g., the vent is small, large, or very large) may provide useful information to confirm production accounting completeness and improve the identification of cost-effective gas conservation opportunities. This approach may identify venting sources where the release magnitude is not fully appreciated by operators and represents the small number of sources that contribute the majority of methane emissions (discussed in Allen et al, 2013 and Zavala-Araiza D. et al, 2018).

³⁵ The component counts presented in Table 18 are multiplied by corresponding no-leak (CAPP, 1992) and 2017 population average emission factors.

5.1 UTILIZATION OF FACTORS

The following should be considered when estimating air emissions based results presented in this study.

- Application of average factors from this report implies the adoption of standard definitions presented in Section 8 for emission, service, component, equipment, facility and well types.
- Average process equipment and pneumatic device counts presented in Table 3, Table 4, Table 7 and Table 8 should only be applied to corresponding facility subtypes and well status populations derived from Facility IDs and UWIs (one per licenced wellhead) reported in the Petrinex “Facility Volumetric Activity Report.”³⁶
- Application of average process equipment and pneumatic device counts to facility and well populations derived from the AER ST102 and ST37 reports is **not** appropriate because these Facility IDs and UWIs may or may not be utilized for production accounting purposes in Petrinex.
- Population average leak factors only include hydrocarbon emissions occurring at rates greater than the IR Camera and High Flow Sampler MDLs. To estimate fugitive emissions occurring below these MDLs, no-leak emission factors should be multiplied by the population of components belonging to the facilities and wells of interest. This approach enables a better understanding of relative contributions and facilitates inclusion of operator estimated fugitives into emission inventories

³⁶ Field observations were correlated with Facility IDs and UWIs (one per licenced wellhead) reported during the survey period in Petrinex. A well licence number identifies an individual surface wellhead and provides a better indication of well populations than UWI (i.e., there may be multiple production strings (UWI) for a single surface wellhead).

6 REFERENCES

- Alberta Energy Regulator (AER). 2017. Annual Dehydrator Benzene Inventory List for the 2016 reporting year. Calgary, AB.
- Alberta Energy Regulator (AER). 2016a. Directive 060: Upstream Petroleum Industry Flaring, Incinerating, and Venting. Calgary, AB. Available at: <https://www.aer.ca/rules-and-regulations/directives/directive-060>.
- Alberta Energy Regulator (AER). 2016b. Manual 011: How to Submit Volumetric Data to the AER. Calgary, AB. Available at: www.aer.ca/documents/manuals/Manual011.pdf
- Allen, D. T., Pacsi, A. P., Sullivan, D. W., Zavala-Araiza, D., Harrison, M., Keen, K., Seinfeld, J. H. (2013) Measurements of methane emissions at natural gas production sites in the United States. <http://www.pnas.org/content/110/44/17768>
- Ariel Corporation. 2018. Compressor Emissions Reduction Technology. Mount Vernon, OH. Retrieved March 2018 from <https://www.arielcorp.com/Technical-Papers/Compressor-Emissions-Reduction-Technology/>
- Bacharach, Inc. 2015. HI FLOW® Sampler - For Natural Gas Leak Rate Measurement: Operation and Maintenance Manual. Rev 7. New Kensington, PA. Available at: <https://www.mybacharach.com/wp-content/uploads/2015/08/0055-9017-Rev-7.pdf>
- Brandt A R, Heath G A and Cooley D. 2016. Methane leaks from natural gas systems follow extreme distributions Environ. Sci. Technol. 50 12512–20. Available online at <http://pubs.acs.org/doi/abs/10.1021/acs.est.6b04303>
- British Columbia Oil and Gas Commission (OGC). 2016. Flaring and Venting Reduction Guideline. Victoria, BC. Available at: <https://www.bcogc.ca/content/flaring-and-venting-reduction-guideline>
- Cal Scan Solutions. 2017. Hawk Vent Gas Meter: Solutions for Low Flow Vent Gas Measurement. Edmonton, AB. Available at: http://www.calscan.net/solutions_GreenGasMeasurement.html
- Canadian Association of Petroleum Producers (CAPP). 2014. Update of Fugitive Emission Equipment Leak Emission Factors. Prepared by Clearstone Engineering Ltd., Calgary, AB. Available at: <http://www.capp.ca/publications-and-statistics/publications/238773> .
- Canadian Association of Petroleum Producers (CAPP). 2007, Best Management Practice for Fugitive Emission Management. Prepared by Clearstone Engineering Ltd., Calgary,

AB. Available at: <http://www.capp.ca/publications-and-statistics/publications/116116>

Canadian Association of Petroleum Producers (CAPP). 2005 A National Inventory of Greenhouse Gas (GHG), Criteria Air Contaminant (CAC) and Hydrogen Sulphide (H₂S) Emissions by the Upstream Oil and Gas Industry Volume 5, Compendium of Terminology, Information Sources, Emission Factors, Equipment Sched's and Uncertainty Data September 2004, Tables 3.1 and 4.1, Publication No. 2005-0015

Canadian Association of Petroleum Producers (CAPP). 1992. A Detailed Inventory of CH₄ and VOC Emissions from Upstream Oil & Gas Operations in Alberta, Vol III, Results of the Field Validation Program, Table 7, Picard et al, March 1992.

Canadian Council of Ministers of the Environment (CCME). 1995. Environmental Guidelines for Controlling Emissions of Volatile Organic Compounds from Aboveground Storage Tanks. Document No. CCME-EPC-87E.

Canadian Energy Partnership for Environmental Innovation (CEPEI). 2006. Fugitive Emissions Measurement Protocol. Guelph, ON.

Clearstone Engineering Ltd. 2017. Decision framework for confirming air emission inventory boundaries, data sources and quantification methods for the Alberta upstream oil and natural gas industry. Calgary, AB.

Efron, B and Tibshirani, RJ. 1993. An Introduction to the bootstrap: monographs on statistics and applied probability 57. N Y Lond Chapman HallCRC, in press.

Environment and Climate Change Canada (ECCC). 2014, National Inventory of GHG, CAC and Other Priority Substances by the Upstream Oil and Gas Industry (references years 2001 to 2011) – Volumes 1 to 4. Prepared by Clearstone Engineering Ltd., Calgary, AB.

GreenPath Energy Ltd. 2017a. Alberta Fugitive and Vented Emissions Inventory Study. Calgary, AB. Available at: http://www.greenpathenergy.com/wp-content/uploads/2017/03/GreenPath-AER-Field-Survey-Results_March8_Final_JG.pdf

GreenPath Energy Ltd. 2017b. Alberta Fugitive and Vented Emissions Inventory Study: AER Survey Data. Calgary, AB. Available at http://www.greenpathenergy.com/wp-content/uploads/2017/03/AER-Survey-Data_Mar13.pdf

Heath Consultants Incorporated. 2014. Anti-Static Measurement Bag Brochure. Houston, TX Available at: <http://heathus.com/products/anti-static-measurement-bag/>

- Intergovernmental Panel on Climate Change (IPCC). 2000. Good Practice Guidance and Uncertainty Management in National Greenhouse Gas Inventories. <http://www.ipcc-nggip.iges.or.jp/public/gp/english/>.
- Petrinex. 2018. Query Monthly Volumetric Submissions. Calgary, AB. Available to AER Business Associated online at: <http://www.petrinex.ca>
- Prasino Group. 2013. Final Report for Determining Bleed Rates for Pneumatic Devices in British Columbia. Calgary Alberta. Available from <http://www2.gov.bc.ca/gov/topic.page?id=CEA465B4EB794C01BEAEEC3C4C48AB95>
- Ravikumar A P, Wang J, McGuire M, Bell C S, Zimmerle D and Brandt A. 2018. “Good versus Good Enough?” Empirical Tests of Methane Leak Detection Sensitivity of a Commercial Infrared Camera. Environ. Sci. Technol. 52 (4), pp 2368–2374. Available online at <https://pubs.acs.org/doi/abs/10.1021/acs.est.7b04945>
- Saskatchewan Ministry of Economy (ECON). 2015. Directive S-10: Saskatchewan Upstream Petroleum Industry Associated Gas Conservation Directive. Regina, SK. Available at: <http://publications.gov.sk.ca/documents/310/85153-Directive%20S-10%20Saskatchewan%20Upstream%20Petroleum%20Industry%20Associated%20Gas%20Conservation%20Directive.pdf>.
- Spartan Controls. 2018. Pneumatic Vent Gas Measurement. Prepared for the Petroleum Technology Alliance of Canada (PTAC). Calgary, AB.
- US Environmental Protection Agency (US EPA). 2016. Greenhouse Gas Reporting Rule: Technical Support for Leak Detection Methodology Revisions and Confidentiality Determinations for Petroleum and Natural Gas Systems Final Rule. Docket ID No. EPA-HQ-OAR-2015-0764. Washington, DC. Retrieved from <https://www.regulations.gov/document?D=EPA-HQ-OAR-2015-0764-0066>
- US Environmental Protection Agency (US EPA). 1995. Protocol for Equipment Leak Emission Estimates. Washington, DC. Retrieved from <http://www3.epa.gov/ttnchie1/efdocs/equiplks.pdf>
- Wheeler A., and Ganji A. 2004. *Introduction to Engineering Experimentation*. 2nd Ed. New Jersey: Pearson Prentice Hall.
- Zavala-Araiza D, Herndon SC, Roscioli JR, Yacovitch TI, Johnson MR, Tyner DR, et al.. Methane emissions from oil and gas production sites in Alberta, Canada. Elem Sci Anth. 2018;6(1):27. DOI: <http://doi.org/10.1525/elementa.284>

7 APPENDIX – 2017 AER FIELD SAMPLING PLAN

The following sampling plan was used for the field campaign conducted between 14 August and 23 September 2017.

7.1 OBJECTIVE

Complete a field inventory and measurement campaign to refine models for predicting equipment/component counts and emission rates used in the determination of fugitive equipment leaks and pneumatic venting. The specific data collection tasks to be completed are:

1. Identify Petrinex Facility ID(s) and UWI corresponding to each location and equipment unit surveyed.
2. Count major process equipment (described in Section 8.4 below) and document applicable emission control type (i.e., gas conservation or gas tied into flare).
3. Count components (defined in Section 8.3 below) for each major process equipment unit and identify hydrocarbon service type (as defined in Section 8.2 below).
4. Count pneumatic instruments/pumps and identify their driver (i.e. natural gas, air, electric or other).
5. Conduct an optical gas imaging (OGI) survey and measure any detected leaks (defined in Section 8.1.1 below).

This campaign is targeting up to 500 locations to provide a sample size of at least 30 Facility IDs for each target facility subtype group.

7.2 SITE SELECTION

- Relevant site population is based on April 2017 Petrinex volume data.
- Random selection from facility subtype populations contributing the most to methane emissions and uncertainty (i.e., natural gas, light/medium crude and cold heavy crude production batteries and compressor stations). Selection constrained by:
 - Exclude sites that emit more than 100,000 t CO₂E because these sites are already subject to SGER GHG reporting and verified by independent 3rd party.
 - Exclusion of facility subtype codes with less than 50 instances. Because these subtypes are limited in number, they have a small contribution to provincial emissions.
 - Proximity to a town with accommodation.
 - Locked gates.
- For each selected site:
 - Email notification letter to Petrinex contact that requests:

- The name, phone number and email of the production superintendent(s) or manager(s) responsible for subject locations.
 - The most recent measurement schematic, showing details delineated in Directive 017 Section 1.9.1, for subject locations.
- Call production superintendent or manager to confirm site visit timing and ensure safe access (i.e., avoid locked gates). Alternatively, call company main line available in “Target Facilities.xlsx” (phone numbers for Petrinex operator and licensee are provided).

7.2.1 TARGET FACILITIES

- All target facility subtypes on a location **must be surveyed** with relevant **Facility IDs** selected in the tablet. Facility IDs for target subtypes are pre-loaded onto the tablets.
 - Target Facility IDs can be identified by filtering column A in tab “FacID pivot” of “Target Facilities.xlsx” on the subject location. Target subtypes are noted in column B with relevant Facility IDs in column D (see Figure 20).
- Non-target Facility IDs are excluded from the tablet. Equipment at non-target Facility IDs should **not** be surveyed.
- Before arriving on site, select the subject “surface location” and “Petrinex Facility ID” on the tablet. **When multiple Facility IDs occur, review the measurement schematic and select the ID relevant to the area of the site being surveyed** (this should already be completed by the field coordinator and provided to the field team).
- If a target Facility ID appears in “Target Facilities.xlsx” but is not stated on the measurement schematic, equipment belonging to this Facility ID is very likely off-site. Thus, on-site equipment should not be assigned to the off-site Facility ID.
- For the 10-34-040-04W5 example, a measurement schematic is presented in measurement schematic Figure 21.
 - Equipment for the gas plant is **not** surveyed (ABGP0001456 is not available on the tablet dropdown list).
 - Equipment for the battery is surveyed and assigned to ABBT4120008 because this Facility ID is the only one listed at 10-34-040-04W5 on the measurement schematic.
 - Equipment for the gas gathering system is surveyed and assigned to ABGS0003668 because this Facility ID is the only one listed at 10-34-040-04W5 on the measurement schematic.
 - No equipment is assigned to ABGS0140581, ABBT0140582 or ABBT0140583 because corresponding equipment is actually at other physical locations and operated by other companies (see Figure 22). The physical location of these sites was incorrectly entered into Petrinex.

Facility Location	Target Facility Type?	SubType Name	FacID
10-34-040-04W5	No	Gas Plant Sweet	ABGP0001456
	Yes	Gas Gathering System	ABGS0003668
		Gas Multiwell Group	ABBT0140582
			ABBT0140583
			ABBT4120008

Figure 20: Example of target and non-target Facility IDs for a single location.

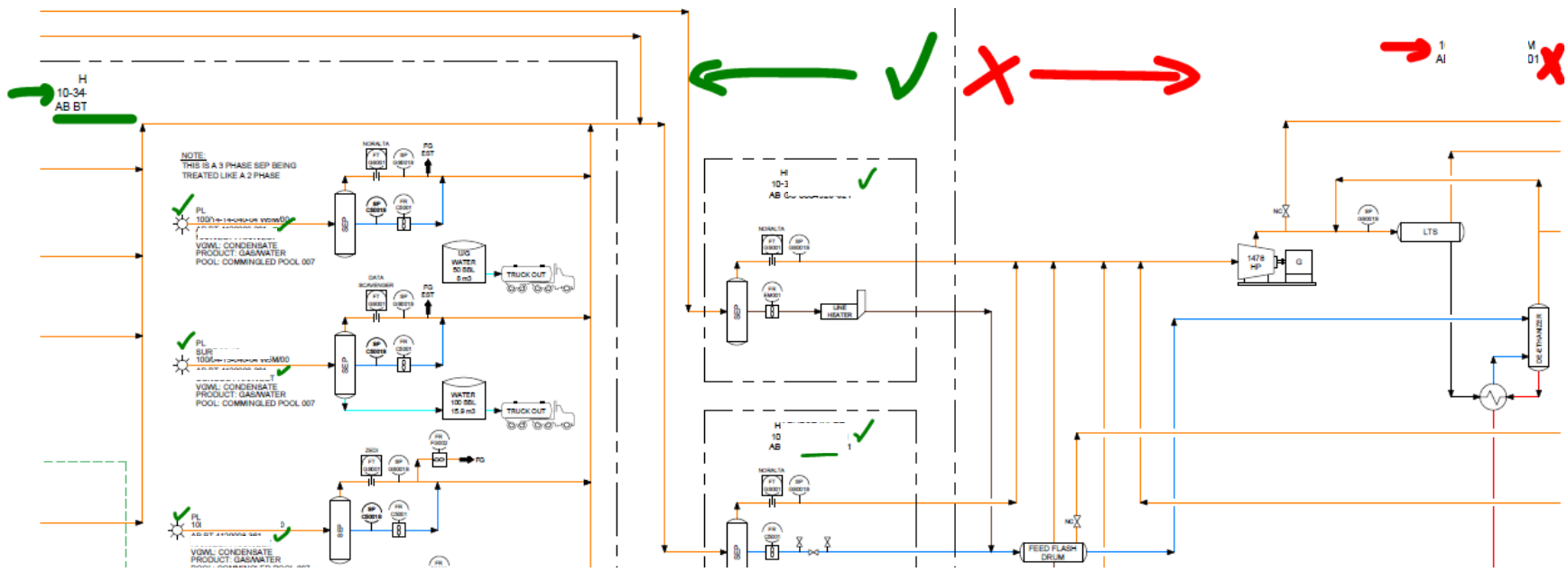

Figure 21: Example measurement schematic with target and non-target Facility IDs.

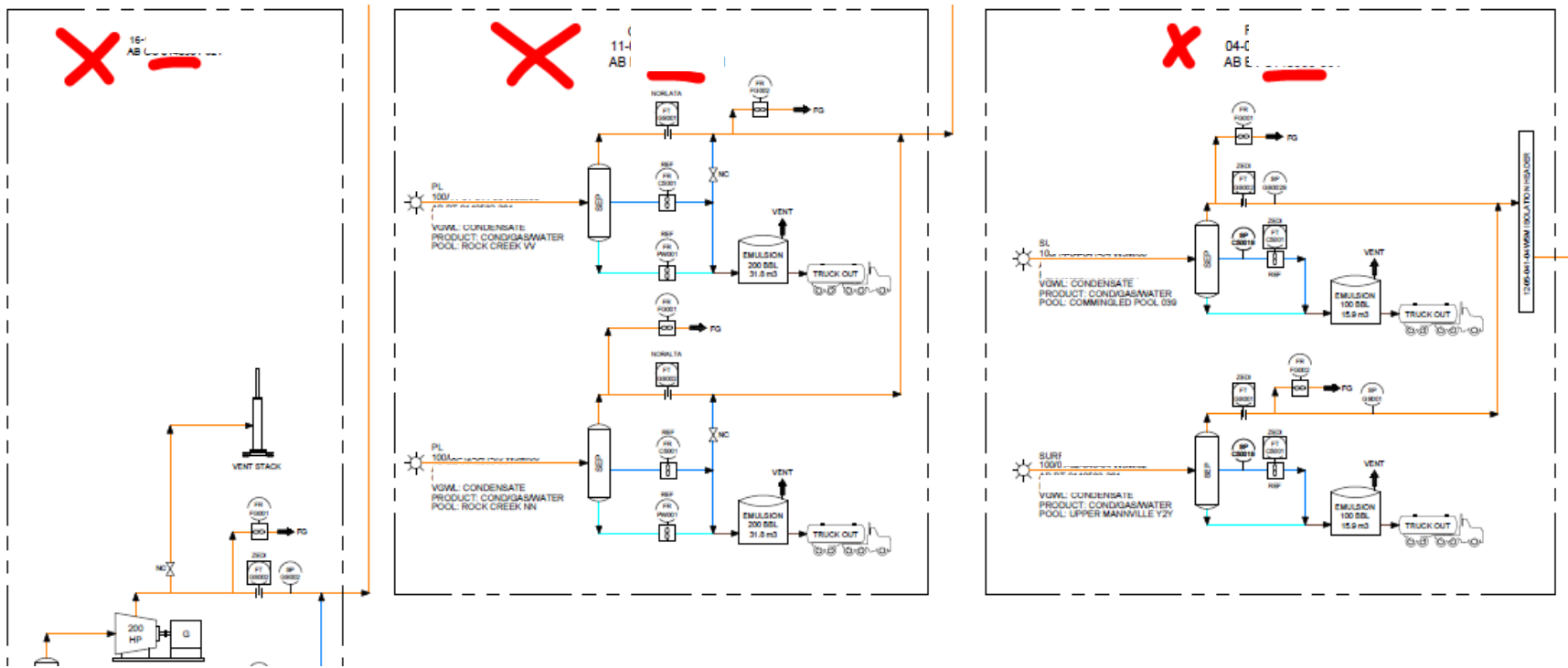

Figure 22: Example measurement schematic with incorrect Facility ID locations listed in Petrinex (equipment is not surveyed).

7.2.2 TARGET WELLS

- **Rules for surveying wells:**
 - All wells at a target location **must be surveyed** and assigned their corresponding Petrinex Facility ID and UWI (pre-loaded in the tablet).
 - Equipment assigned to a UWI includes the wellhead and other equipment immediately downstream and dedicated to the well (e.g., separator, storage tank(s), pneumatics and pumpjack). Equipment common to multiple wells (e.g., flare, compressor, tanks, dehydrator, treater, line heater, pneumatics etc) is assigned to the Facility ID with UWI left empty (i.e., it's assigned to the battery code).
 - Check whether any wells flowing to the target location are off-site. This is accomplished by:
 - Referencing the measurement schematic saved to your tablet desktop.
 - Referencing tab “allappsites” in “Survey Schedule - 2017 Inventory and Leak Measurement Campaign.xlsx” saved to your tablet desktop. All wells flowing to the target Facility ID are identified by filtering column G on the subject Facility ID. Well surface locations are presented in column A and UWI in column I.
 - Alternatively, reference “Target Wells.xlsx”. All wells flowing to the target location are identified by filtering column A in tab “Well pivot” of “Target Wells.xlsx” on the subject location. Corresponding Facility ID are listed in column B with relevant UWI in column C and well surface locations in column D (note that sometimes downhole locations are stated in error).
 - **At least 5 off-site wells** (flowing into subject location) must be surveyed with relevant Facility IDs and UWIs selected in the tablet. Additional off-site wells (up to 10 total) should be surveyed if variability in equipment or pneumatic counts is observed (i.e., there is little value surveying more than 5 wells if they are all the same).
 - Minimize driving time when selecting wells to survey by choosing wells within the same section (i.e., 1 mile x 1 mile). Filter column C in tab “allappsites”.

Downstream Facility Location	Reporting Facility ID	UWI	Well Surface Location	Operator name
10-34-040-04W5	ABBT0140582	ABWI10006104105W500		
		ABWI100110104105W500		
	ABBT0140583	ABWI100113204004W520		
		ABWI100140404104W500		
	ABBT4120008	ABWI100041504004W500		
		ABWI100042404005W520		
		ABWI100052704004W520		
		ABWI100062704004W500		
		ABWI100063204004W500		
		ABWI100092904004W500		
		ABWI100103404004W500		
		ABWI100111004004W500		
		ABWI100132504005W500		
		ABWI100141404004W500		
		ABWI100150304004W500		
		ABWI100162504005W500		
		ABWI102062904004W500		
		ABWI102102804004W500		

Figure 23: Example of wells (UWI) that report (flow) to Petrinex Facility ID.

7.3 DATA COLLECTION PROCEDURES (USING THE TABLET)

For each site surveyed:

1. Select relevant surface location, Facility ID and possibly UWI.
2. Take a photo of the site entrance placard displaying the operator name and location.

7.3.1 PROCESS EQUIPMENT AND COMPONENT COUNTING

1. Take photo of equipment unit
2. Enter site tag number for equipment into [Process equipmentNotes]. For example, separators usually identified by Vxxx, compressors identified by Kxxx, tanks identified by Txxx, etc.
3. Begin component count at the first flange where process fluid enters the unit.
4. End component count at the next process equipment unit. For example, at a well site in Figure 21:
 - a. Start at the wellhead (add first equipment unit) and count components on the wellhead and along the production pipe until the separator inlet flange. Save count.
 - b. Add “separator” and count components on the separator and along production piping until the pipe leaves the site or goes underground. Save count.
5. Only count components in pressurized hydrocarbon service (i.e., those components with the potential to leak hydrocarbon vapours). Components that don’t contain volatile

hydrocarbons (e.g., instrument air, water, lubricating oil, process chemicals, diesel, glycol, etc) are much less likely to emit hydrocarbons to the atmosphere and therefore excluded from the inventory.

6. Only count components equal or greater than 0.5 inches in diameter. For example, instrumentation tubing less than 0.5 inches is not counted because they have a low leak potential (i.e., leak rates are typically very small).
7. When defining equipment units, ensure the “Emission Control” field is populated if off gassing is captured and controlled. Common examples include:
 - a. Storage tanks that are ‘blanketed’ with natural gas and connected to a flare (“Gas Flared”) or vapour recovery unit (“Gas Conserved”).
 - b. Compressor rod-packing vents tied into the flare header (“Gas Flared”) or captured by a Remvue slipstream and used as fuel (“Gas Conserved”).
 - c. Dehydrator still column tied the flare header (“Gas Flared”).
8. When counting in teams, ensure each process equipment unit is entered into one tablet (i.e., can’t have partial counts on two tablets).
9. Document these records in the tablet form “Major Equipment.”

7.3.2 PNEUMATIC DEVICE COUNTING

Pneumatic devices are counted separately from process equipment because the manufacturer and model are required for each device.

1. Each pneumatic device observed is counted and the following fields populated from dropdown lists:
 - a. Driver type (natural gas, air, electric/solar or other)
 - b. Manufacturer
 - c. Model
 - d. Device type
2. Document these records in the tablet form “Pneumatics.”
3. No measurement of venting rates will be completed at this time.
4. I2P-100 pneumatics with serial number greater than F000386281 are 2nd generation low bleed devices.

7.3.3 FUGITIVE AND VENT SCREENING AND MEASUREMENT

1. Conduct a leak detection survey (OGI) of equipment components in pressurized hydrocarbon service. Leak detection (or screening) is performed using a Flir GFx320 or GF320 leak-imaging infrared (IR) camera. Supplemental portable hydrocarbon gas detectors (i.e. Bascom-Turner Gas Sentry CGI-211) are available in the event an IR camera is not available (e.g., insufficient batteries, extra team member available for screening, etc).
2. Tag each detected leak with a unique ID. Leaking component tags, when used, are hung directly on the leaking component, or, if this was not practical, in close proximity, with

appropriate location information included, so the actual leaking component could be easily located for repair. The tags are uniquely numbered, weather resistant, and securely hung using either plastic zip ties.

3. Record a video of noteworthy leaks with the IR camera and document the media #.
4. Measure safely accessible leaks with the following equipment (described in Section 8.5.2):
 - a. The Hi-Flow Sampler
 - b. Calibrated Bag
 - c. VPAC (ultrasonic measurement on the upstream dump valve).
 - d. Calscan Positive Displacement Vent Meter
5. Leaks that are not safely accessible should be recorded with the IR camera and the leak rate estimated based on the intensity and size of the plume visualized using the IR camera. IR camera video files will be included with the final report.
6. Document these leak records and atmospheric temperature and pressure in the tablet form “Vents/Leaks.”
7. For tanks with gas loss from thief hatch but tied into VRU or flare (i.e., unintentional gas loss or leak), enter upstream pressure (kPa) and temperature (C) into comment field.
8. Vents (i.e., intentional gas release from pneumatics, dehydrators, atmospheric storage tanks, unlit flares, etc) are not measured during this campaign. Instead, noteworthy vents (possible super emitters) are recorded with the IR Camera and file name recorded in the tablet.
9. Special cases:
 - a. Well surface casing vent flows (SCVF) should be measured with the high-flow, with emission type = **Leak**, process equipment= “wellhead” and component = “SCVF”. When measuring, be sure you are only capturing the passive release of gas by placing the high-flow nozzle close to the vent but not fully enclosing the vent line (i.e., don’t drawdown gas from the well casing).
 - b. Gas Sample and Analysis System should be measured with the high-flow, with emission type = **Vent**.

7.4 TRAINING AND QAQC

7.4.1 CLASS TRAINING

Completed August 3, 2017 and included the following topics.

1. Introduction (15 minutes)
2. Project overview and objectives– (45 minutes)
 - a. Target facility subtypes and methane emission sources.
 - b. Inventory boundaries and alignment with Petrinex Facility IDs (i.e., site selection rules).
 - c. Field data collection elements.
3. Demonstration of data collection application – (45 minutes)
 - a. Each field team member will be provided a tablet to follow procedures for:
 - i. Entering site location and Petrinex Facility ID.
 - ii. Entering leak measurement results.
 - iii. Entering equipment and component counts.
 - iv. Uploading data after every day.
4. Break (15 minutes)
5. Field safety overview – (45 minutes)
 - a. Field coordinator and lines of communication.
 - b. Safe work procedures.
 - c. Job Hazard Assessment (JHA).
 - d. Incident and near-miss reporting and investigation.
6. Component counting – (75 minutes)
 - a. Basic component categories and counting rules.
 - b. Potential issues.

7.4.2 FIELD TRAINING

Completed August 14 and 15, 2017 and includes:

1. Each team member complete component count of the same equipment unit. Counts compared until team agreed results were consistent with rules stated above.
2. Each team member completes a leak measurement of the same component. Results compared until team agreed results are the same.

7.4.3 DATA COLLECTION ERROR MANAGEMENT

Despite the training, definition standardization and tablet dropdown pick lists; data collection errors are anticipated. To identify and mitigate errors, records are reviewed daily by the field team coordinator. When observed:

1. Errors are corrected upon observation in the subject csv file with cells containing proposed changes highlighted yellow.
2. Modified data rows are saved to corresponding xlsx versions of MajorEquipment, Pneumatics and Vents. Column A of the xlsx is populated with the subject zip file epoch # and Column B is populated with the subject csv file epoch #. Columns C and greater contain records from their source file.
3. The 'error spreadsheet' is emailed to Clearstone on Friday of every week for review and confirmation that the proposed change is reasonable.
4. Systematic errors are communicated to field teams to prevent further occurrence.
5. Clearstone changes problematic records in its database.

7.4.4 DATA COMPLETENESS

It's possible that records collected by field inspectors and saved to tablets are not uploaded to the Clearstone database (e.g., dropbox upload failure). To check whether 'data leakage' has occurred, backup files saved on each tablet are parsed and imported to a back Clearstone database. Missing records are identified by comparing primary and backup database records.

This check was completed on September 19 (for data collected from August 14 to September 10) and no missing data was observed (as evidenced in P:\Alberta Energy Regulator\2017 - Phase 3 (Field Campaign)\QAQC\Review Major Equipment Aug 14 to Sept 10.xlsx).

The check was completed after all field data collection was finished and no missing data was observed (as evidenced in P:\Alberta Energy Regulator\2017 - Phase 3 (Field Campaign)\QAQC\Missing Data\).

7.5 INSPECTOR SAFETY AND CONDUCT

Safety is of paramount concern to the AER. Field Operations staff will conduct their work in accordance with the following field safety procedures.

1. Each field team member must review and sign (last page) the attached file "AER Field Work.pdf" (14 pages). This "standing hazard identification and assessment" prioritizes typical field work activities according to risk; identifies hazards; and the engineering, administrative and PPE controls we are responsible to implement before work can proceed. Keep a copy with you for reference during the campaign. If you have any questions, please bring them forward August 14 during our first field safety meeting.

2. When site conditions change (e.g., arrival at a sour site) or if there is any doubt regarding potential job hazards, your team **must** complete and sign the pre-job field level hazard assessment “AER Hazard Identification and Assessment.pdf”. We will complete this assessment August 14 at the first field location before starting any work. Signed copies must be emailed to : (preferably at the end of each week).
3. Our team will follow Greenpath safe work practices and procedures attached. In particular, please read the safe work procedure: “4.5 Inspecting a Facility with the IR camera.docx” before August 14. This is directly applicable to the work you will be doing (i.e., IR camera inspection, leak measurement and component counting).
4. All incidents (injury, property loss/damage, security) and near misses (event that has the potential to cause serious injury or damage) must be reported to your immediate supervisor (following supervision and reporting structure below) and documented using the appropriate form attached.

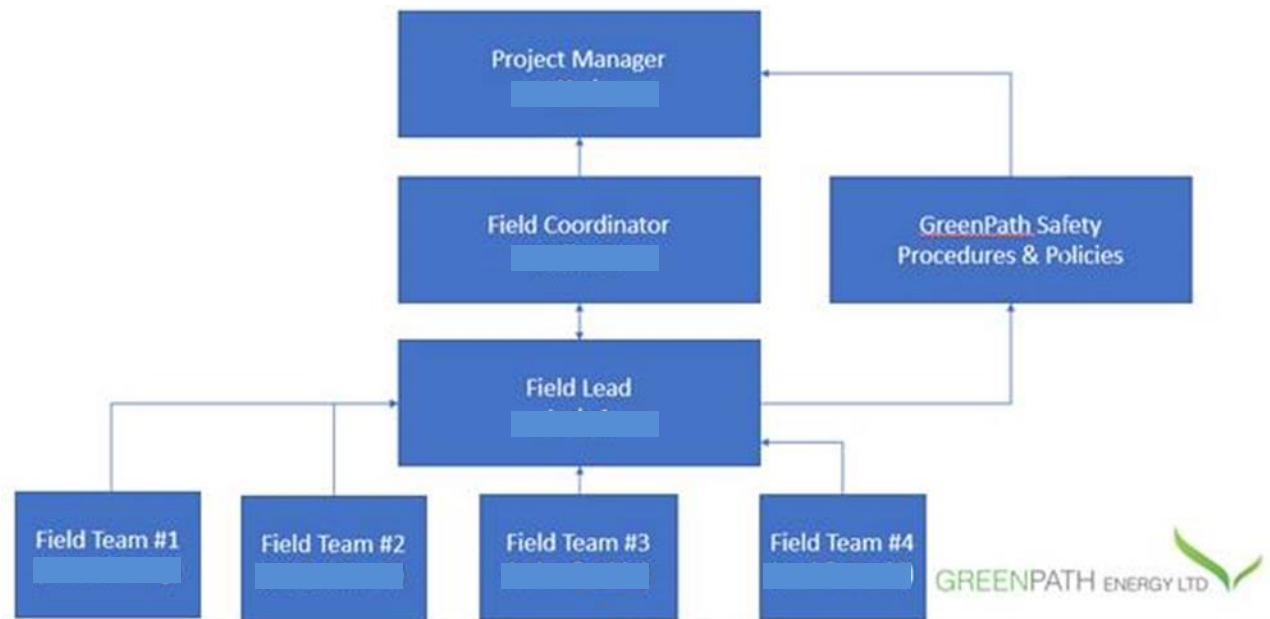

5. Contact details for all team members are provided in the following table.

The documents attached will be saved to each field tablet (Desktop “Safety” folder) and should be referenced throughout the campaign.

8 APPENDIX – STANDARDIZED DEFINITIONS

This glossary provides definitions relevant to the classification of venting and fugitive emissions sources.

8.1 EMISSION TYPES

Emission types are defined as follows:

8.1.1 LEAK

It is important that an objective leak definition be established for application in a leak management program and that this definition meet or exceed common industry or regulatory standards. A leak is the unintentional loss of process fluid past a seal, mechanical connection or minor flaw at a rate that is in excess of normal tolerances allowed by the manufacturer or applicable health, safety and environmental standards. An equipment component in hydrocarbon service is commonly deemed to be leaking when the emitted gas can be visualized with an infrared (IR) leak imaging camera³⁷, detected by an organic vapour analyzer in accordance with U.S. EPA Method 21 (i.e., hydrocarbon concentration screening value of 10,000 ppmv or more), or detected by any other techniques with similar or better detection capabilities.

8.1.2 VENT

An intentional release of hydrocarbon gas directly to the atmosphere. Venting does not include partial products of combustion that might occur during flaring or other combustion activities.

To be consistent with regulatory definitions (e.g., US EPA and Western Climate Initiative jurisdictions), the following emission sources are defined as vents unless they are connected to a vapour recovery or control system and gas is observed to be leaking from corresponding equipment.

- Depressurization of process equipment (e.g., blowdowns).
- Engine and turbine starters.
- Glycol dehydrator off-gas.
- Loading hydrocarbon liquids (into truck or rail tankers).
- Pneumatic instruments and pumps.
- Storage tanks open to the atmosphere (e.g., working, breathing and flashing losses).
- Well liquid unloading.

³⁷ The IR camera is not always as sensitive as screening using organic vapour analyzers, but has been demonstrated to be sufficiently sensitive to detect the big leaks that are contributing most of the emissions.

- Well servicing, completion and testing flows.
- Well surface casing vent flows.
- Unlit flare stacks.

8.2 SERVICE TYPES

Service types relevant to the classification of fugitive emission leaks are defined as follows and refer to the hydrocarbon in contact with the leaking component. A component is considered to be in hydrocarbon service when the process fluid being handled contains greater than 10 percent hydrocarbons on a mass basis.

8.2.1 HEAVY LIQUID

Process fluid that is a hydrocarbon liquid at the operating conditions and has a vapour pressure of less than 0.3 kPa at 15°C. Heavy crude oil and crude bitumen fall into this category.

8.2.2 LIGHT LIQUID

Process fluid that is a hydrocarbon liquid at the operating conditions and has a vapour pressure of 0.3 kPa or greater at 15°C. Light/medium crude oil, condensate and NGLs fall into this category.

8.2.3 PROCESS GAS

Process fluid that is a hydrocarbon gas at the subject operating condition.

8.3 COMPONENT TYPES

Component types relevant to the classification of fugitive emission leaks are defined as follows:

8.3.1 RECIPROCATING COMPRESSOR ROD-PACKINGS

Packing systems (seals) are used on reciprocating compressors to control leakage around the piston rod on each cylinder. A reciprocating compressor is deemed to have one seal associated with each compressor cylinder regardless of whether it is really a single or tandem seal. Controlled rod-packing vent lines that are tied into a flare header, VRU or other gas capture system have a very low probability of leaking to the atmosphere and therefore excluded from the component populations used to calculate population-average leak factors.

8.3.2 CENTRIFUGAL COMPRESSOR SEALS

Centrifugal compressors generally require shaft-end seals between the compressor and bearing housings. Either face-contact oil-lubricated mechanical seals or oil-ring shaft seals, or dry-gas shaft seals are used. A centrifugal compressor has two seals, one on each side of the housing

where the shaft penetration occurs. Controlled seal vent lines that are tied into a flare header, VRU or other gas capture system have a very low probability of leaking to the atmosphere and therefore excluded from the component populations used to calculate population-average leak factors.

8.3.3 CONNECTORS

Each threaded, flanged, mating surface (cover) or mechanical connection is counted as a single connector. Welded or backwelded connections are not counted. Some types of components may have more than one set of connections associated with them. For example a union may have 3 sets of connecting surfaces (2 end connections and a center connection), a nipple or reducer may have 2 (one at each end), and tee may have 3 (one at each end). If all 3 connection points on a union are threaded then a union would be classified as 3 connectors. A union that has welded end connections would be counted as only one connector.

8.3.4 CONTROL VALVE

A valve equipped with an actuator for automated operation to control flow, pressure, liquid level or other relevant process parameter. This category accounts for leakage from around the valve stem and from all fittings on the valve body. The end connections and any internal leakage past the valve seat are counted separately (see connectors and open-ended valves or lines, respectively).

8.3.5 METERS

A flow measurement device is counted as a single component. The connections on the upstream and downstream sides of the device are counted as separate components.

8.3.6 OPEN-ENDED LINES

Each valve in hydrocarbon service that has process fluid on one side and is open to the atmosphere on the other (either directly or through a line) is counted as an open-ended line. If the open side of the valve is fitted with a properly installed cap, plug, blind flange or second closed block valve, or is connected to a control device, then it is no longer considered to be open-ended. A drain valve that discharges into a free-venting storage tank or sump is counted as an open-end line. The valve stem and body, and the connector on the process side of the valve are counted as separate components.

8.3.7 PRESSURE-RELIEF VALVE

Each pressure-relief valve that discharges directly to the atmosphere or through a vent system is counted as a single component. If the valve discharges to a control device (e.g., flare or thermal oxidizer), or has a rupture disk installed upstream along with a monitoring system to indicate

when the rupture disk has failed, then the valve is not counted. The connection on the upstream side of the valve is counted as a separate component. The connection on the downstream is not counted unless there is gas pressure on that side.

8.3.8 PUMP SEALS

Each pump in hydrocarbon service may leak from around the pump shaft and is typically controlled a packing material, with or without a sealant. It may be used on both the rotating and reciprocating pumps (and includes pneumatic injection pumps). Specially designed packing materials are available for different types of service. The selected material is placed in a stuffing box and the packing gland is tightened to compress the packing around the shaft.

8.3.9 REGULATORS

Most regulators are equipped with a vent where gas is released in the event the diaphragm inside becomes damaged. Often, this venting either goes unnoticed or is assumed to be normal operation of the regulator. All regulators should be checked for such leakage. Leakage from around the connections to the regulator should be classified as connectors

8.3.10 THIEF HATCH

Storage tanks connected to a VRU or flare do not emit gas unless the internal tank pressure exceeds the PRV or thief hatch set pressures (and intermittent venting occurs). When the tank pressure drops, the PRVs return to a closed position and typically don't leak. However, once opened, thief hatches remain partially open until an operator closes the hatch. Gas loss from partially open thief hatches is unintentional and therefore classified as a leak.

Gas losses from storage tanks open to the atmosphere (i.e., not connected to a VRU or flare) are classified as a process vent (not a leak).

8.3.11 VALVES

A valve that is **not** a control valve. This category accounts for leakage from around the valve stem and from all fittings on the valve body. The end connections and any internal leakage past the valve seat are counted separately (see connectors and open-ended valves or lines, respectively).

8.3.12 WELL SURFACE CASING VENT FLOW (SCVF)

A wellhead vent port that permits the flow of gas and/or liquid out of the surface casing/casing annulus (often referred to as internal migration). This condition exists when gas enters the exterior production casing annulus from a source formation below the surface casing shoe or through a compromised section of casing wall (i.e. a casing failure).

It is important to recognize the following difference between venting from surface casing and venting from production casing.

- Production casing venting is purposely initiated by the operator, and undertaken to stimulate oil well production. This is an intentional activity and therefore **not** classified as a leak.
- Surface casing vent flows (SCVF's) are an undesirable result of wellbore leakage, and most commonly attributed to poor well cementing practices. These leaks are classified as a fugitive emission source.

8.4 PROCESS EQUIPMENT TYPES

Process equipment types relevant to the UOG are described in Table 20.

Process Equipment	Description
Air Cooled Heat Exchangers	<p>Air cooled heat exchangers, or air coolers, use fans to move air across tube bundles to cool down the circulating fluid inside the tubes. Air coolers are categorized as either forced draft or induced draft depending on the location of the fan.</p> <p>Forced draft air coolers have fans below the tube bundles, pushing the air up across the tubes. Flow in forced draft air coolers is more turbulent than in induced draft coolers, resulting in a greater heat transfer with lower costs. The low escape velocity of the heated air results in poor distribution of the recirculated air.</p> <p>Induced draft air coolers have fans above the tube bundles, pulling air up across the tubes. Induced draft coolers use less power, have more even air distribution, and higher escape velocities, which lead to less recirculation of the heated air. However, they cost more and are noisier than forced draft air coolers.</p>
Catalytic Heater	<p>A catalytic heater is a flameless heat source that uses chemical reactions to break down molecules and produce heat. In the presence of a catalyst which is within the heater, counter current combustion or catalytic combustion occurs when natural gas (or liquid propane gas) in the presence of oxygen creates carbon dioxide, water and heat. In this situation the ignition temperature of natural gas occurs at substantially lower temperatures, therefore no flame is involved in the combustion process and far infrared wave emitters are created, producing radiant heat. Once the oxidation begins, the reaction and heating continues until either the oxygen or fuel source is eliminated.</p>

Process Equipment	Description
Catalytic Incinerator	Catalytic incinerators also known as catalytic oxidizers are equipment for the thermal destruction of hazardous air pollutant (HAP). Oxidizers are used to thermally destroy, by oxidization, the HAP that cannot be recovered nor burned in flares. In the ideal oxidizer, the wastes are converted to carbon dioxide and water, and when the wastes contain HAPs such as sulfur or halogenated compounds, they are converted to non-hazardous compounds. The catalysts, such as platinum, are used to enhance the reaction, resulting in lower operating temperatures and energy requirements for the process.
Centrifugal Compression	Centrifugal compressors are typically driven by natural gas fired turbines and used for large volume, high pressure and high reliability applications such as natural gas transmission or gas plant sales. Centrifugal compressors are dynamic compressors, meaning energy is transferred from a moving set of blades to the gas. This energy takes the form of velocity and pressure. Centrifugal compressors use an impeller consisting of radial or backward bending blades. As the impeller rotates, gas between the rotating blades is moved from the area near the shaft radially outward into a diffuser. Energy is transferred to the gas while it is travelling through the impeller. Some of the energy results in an increase in pressure, some contributes to the velocity of the gas. This velocity decreases in the diffuser, resulting in a higher pressure and compression of the gas.
Deepcut Plant	Deep cut is any process that recovers hydrocarbon liquids from natural gas in excess of gas transmission pipeline specifications. These processes are typically located at large gas or straddle plants and may feature turboexpander, lean oil absorption or joule Thompson (JT) technology.
Dehydrator - Desiccant	Dehydrators are widely used in gas production and processing operations for removing water vapour from natural gas. Desiccant dehydrators are filled with solid desiccants which absorb water from gas stream. Examples of solid desiccants employed in the UOG industry include silica gel, activated alumina and molecular sieves. Desiccant dehydrators features at least two vessels that operate in a cyclic manner alternating between drying and regeneration. During regeneration, a heated natural gas stream passes through the desiccant to desorb water and is typically recycled back to the wet gas flow so zero venting occurs normal operation. Another desiccant example is calcium chloride that gradually dissolves into brine as water vapour is removed from the gas. Instead of regenerating, the calcium chloride is replaced when the ‘working salt bed’ depth approaches the minimum required to achieve the specified dew point. Natural gas is vented each time the vessel is depressurized for the desiccant refilling (i.e., not a source of continuous venting).

Process Equipment	Description
Dehydrator - Glycol	Dehydrators are widely used in gas production and processing operations for removing water vapour from natural gas. Glycol dehydrators use liquid desiccant (most commonly tri-ethylene glycol (TEG) and di-ethylene glycol (DEG)) to absorb water vapour from wet gas streams that have a tendency to absorb small amounts of hydrocarbons (primarily benzene, hexane and heavier hydrocarbons, with some methane). When the glycol is regenerated in the reboiler, the water and residual hydrocarbons not released in the flash tank are liberated and vented to the atmosphere (i.e., a source of continuous venting).
Diesel Engine	Diesel engine, any internal-combustion engine in which air is compressed to a sufficiently high temperature to ignite diesel fuel injected into the cylinder, where combustion and expansion actuate a piston. It operates on either a two-stroke or four-stroke cycle; however, unlike the spark-ignition gasoline engine, the diesel engine induces only air into the combustion chamber on its intake stroke. Diesel engines are typically constructed with compression ratios in the range 14:1 to 22:1.
External Floating Roof Tank	A typical external floating roof tank (EFRT) consists of an open-topped cylindrical steel shell equipped with a roof that floats on the surface of the stored liquid. The floating roof consists of a deck, fittings, and rim seal system.
Flare Knockout Drum	Flare Knockout Drums (FKOD) drums are used to remove liquid droplets before waste gas enters the flare stack. Drum sizing is based on the separation of liquid droplets that occurs when drag force on the droplet equals the gravitational force. Flare knockout drums are located above or below ground and can be located by following piping to the flare stack.
Fractionation Tower	Fractionation towers (or distillation column) include de-ethanizer (first stage), de-propanizer (second stage) and de-butanizer (third stage) distillation towers in a fractionation train. Further explanation provided under Fractionation Plant.
Fractionation Plant	<p>Fractionation plants process natural gas (or crude oil) through one or several fractionators and are typically part of natural gas plants, chemical plants or refineries.</p> <p>1) Fractionation or is a unit operation utilized to separate mixtures into individual products. Fractionation involves separating components by relative volatility and difference in boiling point.</p> <p>2) The recovered NGL (or crude oil) stream is sometimes processed through a fractionation train consisting of three fractional distillation towers in series: a deethanizer, a depropanizer and a debutanizer. The overhead product from the deethanizer is ethane and the bottoms are fed to the depropanizer. The overhead product from the depropanizer is propane and the bottoms are fed to the debutanizer. The overhead product from the debutanizer is a mixture of normal and iso-butane, and the bottoms product is a C5+ mixture.</p>

Process Equipment	Description
Gas Sample and Analysis System	This system consists of piping and regulator to collect a slipstream of process gas for analysis by a gas chromatograph. It normally draws a continuous stream of natural gas sample with a small fraction used for analysis and then vents both the unused and spent portions to the atmosphere.
Gas Boot	Gas boots (also known as vapor recovery towers) are typically located at oil production sites and separate hydrocarbon vapor from liquid or emulsion streams. These vessels operate at low pressure (typically 3 to 5 psig) to allow final flashing of vapors after separation and prior to storage. Captured gas can be used for onsite fuel demands, incinerated/flared or directed sales line.
Gas Meter Building	Building dedicated to gas metering for downstream sales. This includes one or more meter runs with corresponding isolation valves; temperature and pressure sensors and, in some cases, pressure regulation.
Gas Pipeline Header	A header pipe having several openings through which it collects or distributes hydrocarbon gas from/to other pipes (i.e., a tie-in header).
Gas Sweetening: Amine	<p>The removal of H₂S from sour gas is called sweetening. Sweetening units are typically installed at sour gas plants or at smaller sites to remove H₂S from fuel gas. The process for sweetening sour gas with regenerative solvent typically features two towers (i.e. Absorber and Regenerator). The sour gas flows into the lower part of the absorber or contactor. This vessel usually contains 20 to 24 trays, but for small units, it could be a column containing packing. Lean solution containing the sweetening solvent in water is pumped into the absorber near the top. As the solution flows down from tray to tray, it is in intimate contact with the sour gas as the gas flows upward through the liquid on each tray. When the gas reaches the top of the vessel, virtually all the H₂S and, depending on the solvent used, all the CO₂ have been removed from the gas stream. Then, the rich solution from the bottom of vessel flows to the regenerator and recirculated back to the absorber.</p> <p>Most of the chemical sweetening regenerative solvents are alkanol amines, which are compounds formed by replacing one, two, or three hydrogen atoms of the ammonia molecule with radicals of other compounds to form primary, secondary, or tertiary amines respectively. Amines are weak organic bases that are used to remove CO₂ and H₂S from natural gas as well as from synthesis gas. These compounds combine chemically with the acid gases in the contactor to form unstable salts. The salts break down under the elevated temperature and low pressure in the still. The common amine solvents are Monoethanolamide (MEA), Diglycolamine (DGA), Diethanolamine (DEA), and Triethanolamine (TEA).</p>

Process Equipment	Description
Gas Sweetening: Iron Sponge	The removal of H ₂ S from sour gas is called sweetening. Iron sponge sweetening features wood chips that are impregnated with a hydrated form of iron oxide. The material is placed in a pressure vessel through which the sour gas is flowed. Because this is a batch process, usually two vessels are installed—one in service and the other on standby. The H ₂ S reacts with the iron oxide to form iron sulfide. While it is possible to regenerate the iron sulfide with air to restore the iron oxide, in practice this is not done. Instead, the tower containing the spent iron sponge is taken out of service, and the standby tower is placed in service. The spent iron sponge is moistened with water, removed, and disposed of at an approved disposal site, and the tower is filled with a new charge of iron sponge.
Gas Sweetening: Sulfinol	The removal of H ₂ S from sour gas is called sweetening. The Sulfinol process is a hybrid process using a combination of a physical solvent, sulfolane, and a chemical solvent, Diisopropanolamine (DIPA) or Methyl diethanolamine MDEA. The physical solvent and one of the chemical solvents each make up about 35 to 45% of the solution with the balance being water. The sulfinol process is economically attractive for treating gases with a high partial pressure of the acid gases
Gas Sweetening: Sulfreen	The removal of H ₂ S from sour gas is called sweetening. The Sulfreen process is a dry-bed, sub-dew point absorption process based on the extension of the Claus reaction, i.e. catalytic oxidation of H ₂ S to S. Basically consists of two (occasionally three for large capacities) Sulfreen reactors in series with the Claus reactors. Activated Alumina is used as a catalyst. Regeneration is needed since the sulphur accumulates on the catalyst decreasing its activity.
Incinerator	Incinerators (also known as thermal oxidizers) are equipment for the thermal destruction of hazardous air pollutants (HAP). They consist of a chamber through which waste gas flows with sufficient air and fuel to obtain high combustion temperatures. Oxidizers are used to thermally destroy, by oxidization, the HAP that cannot be recovered nor burned in flares.
Internal Floating Roof Tank	An internal floating roof tank (IFRT) has both a permanent fixed roof and a floating roof inside. There are two basic types of internal floating roof tanks: tanks in which the fixed roof is supported by vertical columns within the tank, and tanks with a self-supporting fixed roof and no internal support columns.
Joule Thomson Refrigeration Plant	Joule Thomson unit is used to lower the gas temperature by using the Joule Thomson effect (expansion cooling). Gas cooling is performed by forcing gas through a valve or porous plug while kept insulated so that no heat is exchanged with the environment. JT unit usually contains a gas to gas heat exchanger, JT valve (control or motor valve) and a two phase separator. In order to increase its effectiveness cooled gas is used to lower the temperature of the gas intake. In this manner very low temperatures can be achieved in high purity gases by constantly recirculating them with the use of a compressor.

Table 20: Process equipment descriptions.	
Process Equipment	Description
LACT Unit	A Lease Automatic Custody Transfer (LACT) unit measures the net volume and quality of liquid hydrocarbons. This system provides for the automatic measurement, sampling, and transfer of oil from the lease location into a pipeline when custody transfer occurs.
Liquid Pipeline Header	A header pipe having several openings through which it collects or distributes hydrocarbon liquids from/to other pipes (i.e., a tie-in header).
Line Heater	Line Heaters are installed on pipelines and typically used to prevent hydrate or wax formation. Natural gas heating may also be done to prevent liquids from condensing in the gathering line or to facilitate subsequent fluid separations.
Liquid Pump	A liquid pump is a device that moves liquids by mechanical action. Pumps can be classified into three major groups according to the method they use to move the fluid: direct lift, displacement, and gravity pumps.
Pig Trap	<p>Pig launchers and receivers are referred to as pig traps. Pig launchers are vessels used for launching a pipe tool (i.e., the pig) into a pipeline for cleaning or inspection purposes. The pig tool is driven through the pipeline by the process fluid and cleans the pipe surface with brushes. Pig receivers are located at the other end of the subject pipeline. Gas is released from pig traps when they are depressurized to load or remove a pig.</p> <p>Pig traps can be of horizontal, vertical or inclined type. For ease of operation, horizontal pig traps are preferred. When space constraints become critical, vertical or inclined pig traps are installed instead of horizontal.</p>
Pop Tank	Pop tanks are atmospheric tanks that receive fluids during pressure relief events.
Power Generator - Natural Gas Driver	A natural gas driven power generator combusts natural gas in a reciprocating engine or turbine to generate electricity.
Process Boiler	A boiler is an enclosed vessel that uses controlled flame combustion and has the primary purpose of recovering and exporting thermal energy in the form of steam, hot water or hot glycol.
Production Tank (fixed roof)	Fixed roof, hydrocarbon production tanks consist of a cylindrical steel shell with a permanently affixed roof, which may vary in design from cone or dome shaped to flat. Losses from fixed roof tanks are caused by changes in temperature, pressure and liquid level or during flashing.
Propane Fuel Tank	Horizontal pressure vessels used for storing propane.
Propane Heater	Propane heaters refer to small space or line heaters fueled by propane.

Process Equipment	Description
Propane Refrigeration	Propane refrigeration plants consist of a refrigeration cycle to cool natural gas and remove hydrocarbon liquids or provide dew point control. Ethylene glycol is injected to achieve the required water dew point and prevent hydrates in the gas stream. The water rich glycol is regenerated to an 80% EG/water mix and re-injected.
Reciprocating Compressor - Natural Gas Driver	Reciprocating compressors are positive displacement compressors that use pistons driven by a crankshaft to deliver high pressure gas. The intake gas enters the suction manifold, then flows into the compression cylinder where it gets compressed by a piston driven in a reciprocating motion via a crankshaft, and is then discharged. Compressors are typically skid mounted, driven by a natural gas fired engine or electric motor, include an air cooled heat exchangers and enclosed by a shed.
Reciprocating Compressor - Electric Driver	
Salt Bath Heater	A salt bath heater utilizes molten salt as a transfer media in lieu of water or thermal oil. The salt liquefies at ~390° allowing a process stream outlet temperature of 300° to 650° to be achieved. Salt Bath Heaters are designed for high temperatures at low operating pressures
Screw Compressor - Natural Gas Driver	Screw compressors utilize a rotary positive displacement mechanism that compresses gas between intermeshing helical lobes and chambers in the compressor housing. As the mechanism rotates, the meshing and rotation of the two helical rotors produces a series of volume-reducing cavities. Gas is drawn in through an inlet port in the casing, captured in a cavity, compressed as the cavity reduces in volume, and then discharged through another port in the casing. They are usually used for boosting the gas from wells to reciprocating compressors in the field or gas plants. Screw compressors are typically skid mounted, driven by a natural gas fired engine or electric motor and enclosed by a shed.
Screw Compressor - Electric Driver	
Scrubber	Vessel containing a catalytic or adsorption substance designed to remove problematic compounds (often H ₂ S or other odourous compounds) from the gas stream.
Separator	A vessel used to separate a mixed-phase stream into gas and liquid phases that are "relatively" free of each other. This includes 2-phase and 3-phase separators.
Shell and Tube Heat Exchanger	Shell and tube heat exchangers are horizontal vessels that take the energy from a hot stream (shell side) and transfer it to a cool stream (tube site), or vice versa. Most of the heat exchangers used in industry are shell and tube, air cooled or plate and frame.

Process Equipment	Description
Stabilization Tower	Stabilization Tower (or stabilizer) is a unit used to stabilize condensate in order to reduce tank venting emissions and recover dissolved gas. It is usually a vertical separator type of vessel with operating conditions at low (atmospheric or lower) pressure and temperature in a region of 70-80 C°. High pressure feed enters in the mid region and momentarily expands. Pressure reduction reduces the boiling point of the feed which causes sudden evaporation (flashing). Stabilizer is heated at bottom, thus creating a reflux which allows condensate with less dissolved gas. Liquids are boiled off of gases and exit at bottom and gases on top. In this manner flash losses are avoided of the top of the tanks.
Storage Bullet	Storage bullets are horizontal pressure vessels used for storing hydrocarbon liquids with high vapour pressures.
Sulphur Recovery Plant	Sulfur Recovery Units, also known as Claus Units, use a feedstock of acid gases from sweetening units and sour-water strippers. The feedstock is sent into a proprietary burner system, where it is burnt sub-stoichiometrically with air. The resulting mixture of hydrogen sulfide and sulfur dioxide reacts to form elemental sulfur (“Claus reaction”), which is then removed through condensation. This initial combustion section is followed by two or three catalytic sections to increase sulfur recovery rates to 94.5% – 97.5%.
Tank Heater	A tank heater also known as immersion heater is installed in a tank to maintain liquid temperature at a certain controlled set point.
Thermal Electric Generator	A thermoelectric generator (TEG) is a solid state device that converts heat flux (temperature differences) directly into electrical energy through a phenomenon called the Seebeck effect (a form of thermoelectric effect).
Treater	A vessel used to break oil-water emulsions and achieve oil pipeline specifications. A treater can use several mechanisms. These include heat, gravity segregation, chemical additives and electric current to break emulsions. There are vertical and horizontal treaters. The main difference between them is the residence time, which is shorter in the vertical configuration compared with the horizontal one. A treater can be called a heater treater or an emulsion treater.
Turbo Expander	Turbo expansion plant is where a turboexpander is used. A turboexpander is a centrifugal or axial flow turbine through which a high pressure gas is expanded to produce work that is often used to drive a compressor or generator. Turboexpanders are very widely used as sources of refrigeration in industrial processes such as the extraction of ethane and natural gas liquids (NGLs) from natural gas, the liquefaction of gases (such as oxygen, nitrogen, helium, argon and krypton) and other low-temperature processes.
Unit Heater	A unit heater is a natural gas or propane fired space heater (such as an office furnace or hot water heater).

Table 20: Process equipment descriptions.	
Process Equipment	Description
Wellhead	A wellhead is the surface equipment (valves, chokes and pressure gauges) used to maintain control of a well and to regulate well production.
Well Pump	A well pump may be a surface pump jack or down-hole progressing cavity pump designed to extract crude oil from a well where there is not enough reservoir pressure to force oil to the surface. Well pumps include natural gas or propane fired engines to create artificial lift. This process of creating artificial lift simply increases the pressure within an oil well to pull oil to the surface.

8.5 TECHNOLOGY TYPES

Technology types used in this study are described in the following subsection.

8.5.1 LEAK DETECTION

8.5.1.1 PORTABLE CATALYTIC/THERMAL CONDUCTIVITY LEAK DETECTOR

Portable catalytic gas sensors are capable of measuring the combustible gas content of a sample. The core of the sensor (pellistor) comprises two platinum wires, one wire (termed the catalytic bead) is coated with a catalytically-treated metal oxide and the other (termed reference bead) is coated with a compound to inhibit catalytic oxidization. These beads are arranged in series on the “unknown leg” of a Wheatstone bridge circuit, and are electrically heated. In the presence of ambient air (i.e. no combustible gases), the sensor is zeroed by adjusting the electrical resistivity of the “known leg” of the Wheatstone bridge so the circuit is balanced (i.e. zero voltage across the bridge). This zeroing operation is automatically done by the instrument when it is turned on, and takes approximately 30 seconds. Once the sensor has been zeroed and a sample of combustible gas and air is supplied, the electrical heating promotes catalytic oxidization of the sample’s combustible gases and oxygen in the air, on the surface of the catalytic bead. This oxidation creates additional heat on the catalytic bead and increases the electrical resistivity of the platinum wire within the bead. This change in electrical resistance can be measured as a voltage difference across the bridge, and is nearly linearly proportional to the combustible gas content of the sample for the 0 to 3% of methane (0 to 60% LEL) range, and slightly less linearly proportional in 3-5% methane (60 to 100% LEL) range. Beyond 100% LEL, the reducing oxygen content of the sample will result in a non-linear sensor response and the signal will fall-off at compositions beyond stoichiometric.

A thermal conductivity sensor (as known as a Katharometer) is required to reliably measure samples with the combustible gas content beyond 100% LEL. The thermal conductivity sensor comprises a balanced Wheatstone bridge of electrically heated resistors. A reference gas (ambient air) is flowed across resistors on opposite legs of the bridge. While a sample gas (methane and ambient air mixture) is flowed across the other pair of resistors on opposite legs of the bridge. The differences in thermal conductivity of the reference and sample flows will affect the cooling rates of the heated resistors and change their resistivity, which is measured as a voltage difference across the bridge. The technique is reliable across a whole range of gas mixture, provided that mixture comprises only two gases and the two gases have different thermal conductivities (e.g. methane and air).

The handheld gas Bascom Turner CGI-201 and 211 Class 1, Division 1 hazardous location compliant instruments which can accurately quantify methane composition, as well as other hydrocarbons which reduced certainty. It is equipped with catalytic combustion sensor to measure hydrocarbon content from 0.05% up to 4% and a thermal conductivity sensor to measure methane 4% to 100%. The CGI-211 has a “Track Gas” mode which is ideal for finding leaks as it has a very fast response time and a beeper/alarm when the instrument detects combustible gases in excess of a user adjustable set point. However using the instrument in “Track Gas” mode only uses the catalytic gas sensor which restricts the operational range to 0 to 4% methane. The catalytic sensor is susceptible to catalyst poisoning from silicon compounds (common in oil and lubricants), sulfur compounds, chlorine and heavy metals. Also, halogen or halide compounds (used in fire extinguishers) and Freon (used in refrigerants) can inhibit the catalytic sensor. However, the sensor should return to normal functionality with 24 to 48 hours of exposure to the ambient air. Finally, the catalytic bead of the sensor is susceptible to thermal stress cracking when exposed to high concentration combustible gases, which generate a lot of catalytic oxidation heat on the bead.

The methane sensor in the instrument should be replaced when sensitivity changes substantially since the last calibration. The instrument can be manually calibrated by supplying a calibration gas to the instrument at atmospheric pressures and adjusting a potentiometer until the correct concentration is displayed by the instrument. Typically, this instrument is calibrated once every six months.

8.5.1.2 PORTABLE ACOUSTICAL LEAK DETECTOR

Portable acoustical leak detectors (e.g., VPAC Model 5131) can estimate the internal leakage past the seat of a valve (through valve leakage). These instruments require the operator to enter the valve type, size and differential pressure (pressure upstream vs downstream of the valve), and place a hand held acoustic probe with some gel on the body of the valve. The acoustic signal observed by the instrument and valve properties are used to estimate the through valve leak rate from an empirical derived database of laboratory tested valves with known through valve leak rates.

While this type of leak detector is easy to use it is only appropriate for valves and can only estimate the through valve leak rate. This instrument cannot estimate the valve stem leak rate and does not give an indication of the hydrocarbon emissions if the valve is in gas service. This instrument is not appropriate for screening an area for fugitive emissions.

8.5.1.3 INFRARED CAMERA

Gas detecting infrared (“IR”) cameras are a fast and easy to use tool for screening fugitive emissions sources. However, IR cameras have limited performance in rain, snow, or fog; and an inability to distinguish between natural gas and hot gases. Also, since IR camera video recording equipment is not rated for usage in Class I, Division 1 hazardous locations, a hot work permit is required, and the screening area must be monitored for LEL concentrations.

IR cameras operate on the principle that all matter emits infrared radiation (light) at different frequencies, depending on its temperature. Gas detecting IR cameras are equipped with an optical filter which only lets through a narrow portion of the infrared spectrum that target gases (e.g. hydrocarbons) are known to have stronger absorption than the other gases in ambient air. Hydrocarbon emissions are registered by the camera as a deficit in the infrared light intensity relative to that of the background. The captured infrared light intensity is processed by the camera, and displayed as a false coloured image in the visible part of the spectrum.

The deficit in infrared light intensity will be more pronounced if the target gas is colder than the background or if the target gas contains heavy hydrocarbons (e.g. C₂ to C₆). Similarly, an opposite response can be observed when the emission source is much hotter than the background, such as a flare with a cold sky background.

8.5.2 LEAK AND VENT MEASUREMENT

8.5.2.1 CALIBRATED BAG

A calibrated bag is a bag for measuring the emission rate from a vent or opened line. The bag has a known volume and a neck sized to fit over vent openings. The leak rate is determined as the volume of the calibrated bag divided by the time it took to fill. The emissions are also sampled to determine the concentration of target gases. The product of the leak rate and target gas concentration give the emission rate of the vent. This method is capable of measuring leaks up to 408 m³/hr of natural gas and is accurate to within ±10% (Health Consultants Inc., 2009).

8.5.2.2 FULL-FLOW FLOW METERS

If possible to fully capture leak emissions, the leak rate can be determined by from the product of the flow rate and the concentration of the target gas in the sampling stream. The target gas concentration can be measured with a vapour analyzer presented in Section 8.5.1 or lab analysis of a grab sample. The sample stream flow rate can be measured with a variety of instruments such as a diaphragm flow meter, rotary meter, orifice meters and ultrasonic flow meter. At

higher flow rates the target gas concentration in the flow stream will be reduced due to additional dilution by ambient air being drawn from around the leak site that is being measured. However, the product of the measured flow rate and target gas concentration should give a consistent estimate of the leak emission rate. A flow rate should be selected such that all the emissions from the leak are captured but not so high that the target gas concentration in the sampling stream is approaching the detectable limit of the instrument. The Hi-Flow Sampler (Section 8.5.2.3) is an example of a product which estimates a hydrocarbon leak rate by capturing all the emissions from a leak. The Calscan positive displacement meter is another example, however, this device measures whole gas flow and is not equipped with a hydrocarbon sensor.

8.5.2.3 HI-FLOW SAMPLER

The Hi-Flow Sampler is an intrinsically safe instrument manufactured and sold by Bacharach, for measuring methane emission rates from leaking components. The instrument is portable (9 kg) and fits inside a backpack. The Hi-Flow Sampler comprises a sampling hose which the operator places on a leak site, an instrumentation box containing a blower and catalytic/thermal conductivity natural gas sensors, a battery pack, and a control pad/display. The Hi-Flow Sampler attempts to capture all the emissions from a leak by continuously drawing a sample of the air around a leak site at a relatively high (up to 17 m³/hr), but adjustable flow rate. The flow rate is determined by the measured pressure differential across an orifice restrictor, and the methane concentration is determined by directing a portion of the flow to a catalytic oxidation/thermal conductivity combustible gas sensor (see Section 8.5.1.1). An identical sensor also measures the background concentration of methane within the vicinity of the leak site. The background methane concentration is discounted from the sampled methane concentration in the assessment of the component leak rate. Finally, a blower which draws the sample through the instrument, exhausts to atmosphere.

This instrument is capable of determining leak rates from 0.085 to 13.6 m³/hr ±10%. The manufacture recommends monthly calibration at a minimum, and more frequent calibration depending on how often the instrument is used and the amount of gas that has been sampled. Since this instrument uses a catalytic/thermal conductivity combustible gas sensor to quantify the sample's methane concentrations, it is susceptible to sensor flooding and poisoning (see Section 8.5.1.1).

Sensor flooding occurs when a high concentration (greater than 5%) of methane is quickly introduced to the sensor methane sensor. Under ideal conditions the instrument would transition from the catalytic sensor (valid for 0% to 5% methane) to the thermal conductivity sensor (valid 5% to 100% methane). However, when too great a methane concentration is quickly introduced to the catalytic sensor, the instrument will report erroneously low reading because the catalytic reaction is oxygen starved and will not trigger the thermal conductivity sensor. To prevent

sensor flooding a source with combustible gas content greater than stoichiometric (approximately 9% methane) must be approached slowly so as to trigger the transition to the thermal conductivity sensor.

8.6 FACILITY SUBTYPE CODES

When operators apply for a production accounting facility identifier (Facility ID), the AER requires that a facility subtype be specified according to the descriptions listed in Tables 2 and 3 of Manual 011 (AER, 2016). Facility subtype codes are presented in Table 21 and grouped according to UOG industry segments. Although these facility descriptions don't provide complete or definitive explanations of process equipment installed, they do provide some insight on the nature of processing activities at subject sites. When combined with volumetric flow data and field inventory statistics, the quantity and size of equipment at discrete sites can be estimated.

UOG Industry Segment	SubType Code	Facility Type	Facility SubType
Well drilling, testing and servicing	381	Battery	Drilling and completing
	371	Battery	Gas test
Light and Medium Crude Oil Production	311	Battery	Crude Oil (Medium) Single
	321	Battery	Crude Oil (Medium) Multiwell Group
	322	Battery	Crude Oil Multiwell Proration
	501	Injection	Enhanced recovery scheme
	502	Injection	Concurrent production-cycling scheme
Cold Heavy Crude Oil Production	508	Injection	Enhanced recovery scheme (issued by AER). No License Required.
	331	Battery	Crude bitumen single-well
	341	Battery	Crude bitumen multiwell group
	342	Battery	Crude bitumen multiwell proration
	343	Battery	Crude bitumen/heavy oil administrative grouping
Thermal Heavy Crude Oil Production	611	Custom Treating	Custom Treating Facility
	344	Battery	In-Situ Oil Sands battery
	345	Battery	In-Situ Oil Sands battery (Sulphur Reporting)
	506	Injection	In-Situ oil sands
Natural Gas Production	902	Battery	Water Source
	351	Battery	Gas Single
	361	Battery	Gas Multiwell Group
	362	Battery	Gas Multiwell effluent

Table 21: Facility Subtypes defined in AER Manual 011.			
UOG Industry Segment	SubType Code	Facility Type	Facility SubType
	363	Battery	Gas Multiwell proration SE AB
	364	Battery	Gas Multiwell proration outside SE AB
	365	Battery	Gas Multiwell Group (issued by AER). No License Required.
	366	Battery	Gas Multiwell proration SE AB (issued by AER). No License Required.
	367	Battery	Gas Multiwell proration outside SE AB (issued by AER). No License Required.
Natural Gas Gathering	601	Compressor Station	Compressor Station
	621	Gas Gathering	Gas Gathering System
	622	Gas Gathering	Gas Gathering System (compression < 75 kW. Issued by AER). No License Required.
Natural Gas Processing	401	Gas Plant	Gas Plant Sweet
	402	Gas Plant	Gas Plant Sour (receives <1 t/d sulphur) - Flaring
	403	Gas Plant	Gas Plant Sour (receives >1 t/d sulphur) - Flaring
	404	Gas Plant	Gas Plant Sour - Injection
	405	Gas Plant	Gas Plant Sour - Recovery
	406	Gas Plant	Gas Plant Sweet - Straddle
	407	Gas Plant	Gas Plant fractionation
	504	Injection	Acid Gas Disposal
Natural gas transmission, storage and distribution	204	Pipeline	Gas transporter
	206	Pipeline	Gas distributor
	505	Injection	Underground gas storage
	631	Gas Gathering	Field Receipt meter station
	632	Gas Gathering	Disposition meter station
	633	Gas Gathering	Interconnected meter station
	634	Gas Gathering	Border crossing meter station
	637	Gas Gathering	NEB field receipt meter station
	638	Gas Gathering	NEB interconnect receipt meter station
	639	Gas Gathering	NEB interconnect disposition meter station

Table 21: Facility Subtypes defined in AER Manual 011.			
UOG Industry Segment	SubType Code	Facility Type	Facility SubType
	640	Gas Gathering	Interconnect PL to PL disposition meter station
Petroleum Liquids Transportation	207	Pipeline	Oil pipeline
	208	Pipeline	NGL pipeline
	209	Pipeline	NEB Regulated Pipeline
	671	Tank Farm-Terminal	Tank loading and unloading terminal
	672	Tank Farm-Terminal	NEB regulated terminal
	673	Tank Farm-Terminal	Third-party tank loading and unloading terminal
Disposal and Waste Treatment	675	Tank Farm-Terminal	RailCar/Oil Loading And Unloading Terminal
	503	Injection	Water Disposal
	507	Injection	Disposal (approved as waste plant)
	509	Injection	Disposal (issued by AER). No License Required.
	612	Custom Treating	Custom Treating Facility (approved as waste plant)

8.7 WELL STATUS CODES

Well status codes are defined for each UWI in Alberta. They feature the following categories that identify the activity and classification of a well and its fluid.

- Fluid - the primary fluid the well produces or injects, such as oil or gas.
- Mode - the mechanism the well uses to produce or inject, such as flowing or pumping, or the inactive phases of a well, such as suspended or abandoned.
- Type - the well type reflects the well's purpose, such as injection or disposal.
- Structure - the well structure reflects when a well has multiple wells that have commingled production, or when a well is completed horizontal and the producing interval is open and draining into a common wellbore.

All four categories may not apply to every UWI. Non-null records are concatenated to form a single well status code for each UWI. The most common well status records are presented in Figure 24 with example counts from December 2017. Emission inventory refinements should focus on the top 9 well status codes that represent 99 percent of the relevant well population.

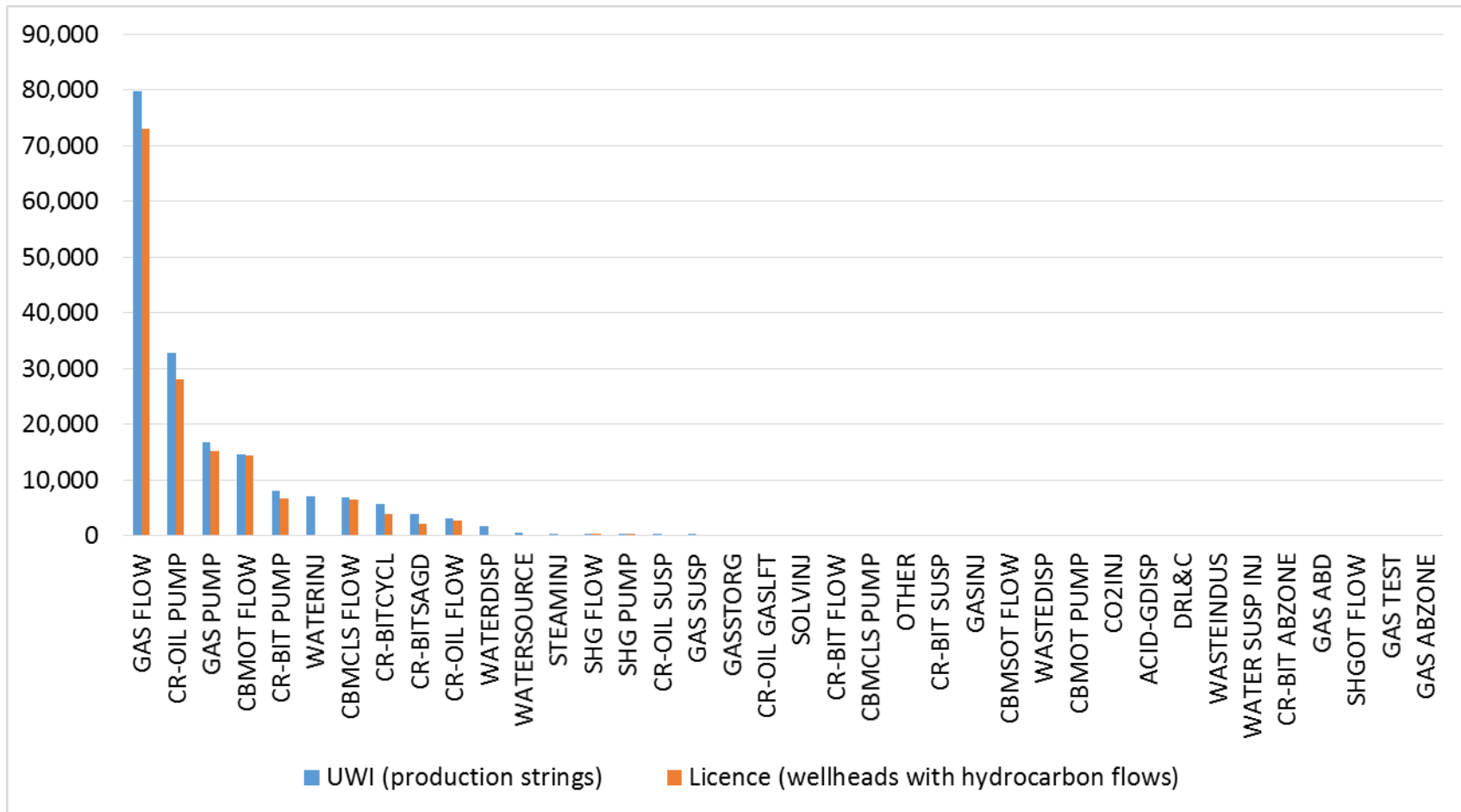

Figure 24: Number of UWIs (representing production strings) and well licences (representing wellheads with hydrocarbon flows) for each well status code reported in Petrinex for December 2017.

9 APPENDIX - METHODOLOGY FOR ASSESSING UNCERTAINTIES

Uncertainties in emission inventories arise through at least three different processes (IPCC, 2000):

- Uncertainties from definitions (e.g., meaning incomplete, unclear, or faulty definition of an emission or uptake).
- Uncertainty from natural variability of the process that produces the emission.
- Uncertainties from the assessment of the process or quantity, including, depending on the method used: (i) uncertainties from measuring, (ii) uncertainties from sampling, (iii) uncertainties from reference data that may be incompletely described, and (iv) uncertainties from expert judgment.

For most purposes it is reasonable to assume that uncertainties from definitions are adequately controlled through the applied QA/QC procedures, and therefore, are negligible. Quantitative uncertainty estimates to account for the latter two contributions may be developed using the Tier 1 approach published by IPCC (2000). This approach employs simple error propagation equations based on the assumption of uncorrelated normally distributed uncertainties under addition and multiplication.

9.1 ERROR PROPAGATION EQUATIONS

An emission inventory may be viewed as the sum of emission estimates for multiple equipment units where the estimate for each equipment is typically the product of an emission factor and a corresponding activity value. For example, emissions from a single source are typically estimated using a relation of the form:

$$ER = EF \cdot A \cdot (1 - CF) \cdot OT$$

Equation 11

Where,

ER	= average emission rate,
EF	= average emission factor,
A	= activity value,
CF	= control factor,
OT	= fraction of the time the source is in service.

Total aggregate emissions from multiple sources are then calculated using the relation:

$$ER_{Total} = ER_1 + ER_2 + \dots + ER_n$$

Equation 12

At a lower calculation level, individual input parameters to Equation 11 may also be determined through a series of multiplication and addition steps. For instance, an emission factor for total fugitive emissions per compressor unit may be expressed by the relation:

$$ER_{Compressor} = ER_{Valves} \cdot N_{Valves} + ER_{Connectors} \cdot N_{Connectors} + ER_{Seals} \cdot N_{Seals}$$

Equation 13

Where, N denotes the number of components and the subscripts denote the type of components. Similarly, in the absence of metered values, fuel usage may be estimate as the production of engine size, engine efficiency, load factor, operating time, and fuel heating value.

Thus, the development of an emissions inventory may be divided in to a series of multiplication and addition steps where uncertainties are aggregated accordingly.

9.1.1 COMBINING UNCERTAINTIES IN MULTIPLICATION AND DIVISION STEPS

Where the activity parameter for a source is continuous (e.g., gas throughput or fuel gas consumption), the IPCC Tier-1 relation for combining uncertainties in multiplication steps is (this is approximate for all random variables):

$$U_{Total} = \sqrt{U_1^2 + U_2^2 + \dots + U_n^2}$$

Equation 14

Where,

U_{Total} = the percentage uncertainty in the sum of the quantities.

U_1, U_2, U_n = the uncertainties in the individual quantities being multiplied.

Thus, the uncertainty in an emission rate calculated using Equation 11 is given by the relation:

$$U_{ER} = \sqrt{U_{EF}^2 + U_A^2 + U_{1-CF}^2 + U_{OT}^2}$$

Equation 15

9.1.2 COMBINING UNCERTAINTIES IN ADDITION AND SUBTRACTION STEPS

Where the activity parameter for a source is a count or integer value (e.g., number of equipment components, number of pneumatic devices, number of compressors, etc.), Equation 16 is used to evaluate the aggregate uncertainty for N sources of the same type (this expression is exact for uncorrelated or independent variables).

$$U_{Total} = \frac{\sqrt{(U_1 \cdot x_1)^2 + (U_2 \cdot x_2)^2 + \dots + (U_n \cdot x_n)^2}}{x_1 + x_2 + \dots + x_n}$$

Equation 16

Where:

x_1, x_2, x_n = are the uncertain quantities being added.

Thus, the uncertainty in an emission rate calculated using Equation 12 is given by the relation:

$$U_{ER_{Total}} = \frac{\sqrt{(U_{ER_1} \cdot ER_1)^2 + (U_{ER_2} \cdot ER_2)^2 + \dots + (U_{ER_n} \cdot ER_n)^2}}{ER_1 + ER_2 + \dots + ER_n}$$

Equation 17

9.2 LIMITATIONS TO RULES OF COMBINATION OF UNCERTAINTIES

The rules stated above are derived below in Section 9.3. These rules have two limitations. First, they can be used only when there is a combination of multiplication and/or addition. Second, the variables in the equations are assumed independent of one another. In case of any dependency between variables, covariance terms must be incorporated in the uncertainty calculations as presented in Equation 20.

9.3 DERIVATION OF ERROR PROPAGATION EQUATIONS

Uncertainty in this work is defined as 95% confidence interval. The uncertainty of a variable may be calculated using Equation 18 which is a linear function of standard deviation.

$$U_{x_i} = \frac{c}{\sqrt{n}} \frac{\sigma_{x_i}}{x_i}$$

Equation 18

Where

U_{x_i} = uncertainty of x_i ,

- σ_{x_i} = standard deviation of x_i ,
- x_i = an arbitrary variable,
- c = 95% confidence level critical value,
- n = number of data points.

Equation 18 is generally used to calculate the uncertainty of variables from measurement data; however, when a variables is calculated as a function of other variables, its uncertainty shall be calculated as an aggregation of other variables' uncertainties. Since the uncertainty is a linear function of standard deviation, rule of propagation of standard deviation shall be used to calculate the uncertainty of a function.

For function x defined as

$$x = f(\chi_1, \dots, \chi_i, \dots, \chi_n)$$

Equation 19

where n is the number of variables, the standard deviation is calculated in terms of standard deviation of its variables, χ_i , using the rule of propagation of standard deviation as express by Equation 20.

$$\sigma_x = \sqrt{\sum_{i=1}^n \sum_{j=1}^n \frac{\partial x}{\partial \chi_i} \sigma_{\chi_i, \chi_j} \frac{\partial x}{\partial \chi_j}}$$

Equation 20

In the above equation, σ_{χ_i, χ_j} is covariance of χ_i and χ_j which is defined as:

$$\sigma_{\chi_i, \chi_j} = \frac{\sum d\chi_i d\chi_j}{N - 1}$$

Equation 21

where N is the population of data. If χ_i are independent, Equation 20 simplifies to

$$\sigma_x = \sqrt{\sum_{i=1}^n \left(\frac{\partial x}{\partial \chi_i} \sigma_{\chi_i} \right)^2}$$

Equation 22

where σ_{χ_i} is the standard deviation of χ_i .

Equation 20 and Equation 22 could be proved by an example. Consider an arbitrary equation x which is a function of three parameters a , b , and c :

$$x = f(a, b, c)$$

Equation 23

The standard deviation of x is defined as

$$\sigma_x = \sqrt{\frac{\sum dx_i^2}{N - 1}}$$

Equation 24

where dx is differential of x and is calculated by Equation 25.

$$dx = \left(\frac{\partial x}{\partial a}\right)_{b,c} da + \left(\frac{\partial x}{\partial b}\right)_{a,c} db + \left(\frac{\partial x}{\partial c}\right)_{a,b} dc$$

Equation 25

Inserting Equation 25 into Equation 24 leads to Equation 26, which aggregates the standard deviations.

$$\begin{aligned}
\sigma_x &= \left(\frac{1}{N-1} \left(\sum \left(\frac{\partial x}{\partial a} \right)_{b,c}^2 da_i^2 + \sum \left(\frac{\partial x}{\partial b} \right)_{a,c}^2 db_i^2 + \sum \left(\frac{\partial x}{\partial c} \right)_{a,b}^2 dc_i^2 \right. \right. \\
&\quad + \sum 2 \left(\frac{\partial x}{\partial a} \right)_{b,c} \left(\frac{\partial x}{\partial b} \right)_{a,c} da_i db_i + \sum 2 \left(\frac{\partial x}{\partial a} \right)_{b,c} \left(\frac{\partial x}{\partial c} \right)_{a,b} da_i dc_i \\
&\quad \left. \left. + \sum 2 \left(\frac{\partial x}{\partial b} \right)_{a,c} \left(\frac{\partial x}{\partial c} \right)_{a,b} db_i dc_i \right) \right)^{1/2} \\
&= \left(\left(\frac{\partial x}{\partial a} \right)_{b,c}^2 \sum \frac{da_i^2}{N-1} + \left(\frac{\partial x}{\partial b} \right)_{a,c}^2 \sum \frac{db_i^2}{N-1} + \left(\frac{\partial x}{\partial c} \right)_{a,b}^2 \sum \frac{dc_i^2}{N-1} \right. \\
&\quad + 2 \left(\frac{\partial x}{\partial a} \right)_{b,c} \left(\frac{\partial x}{\partial b} \right)_{a,c} \sum \frac{da_i db_i}{N-1} + 2 \left(\frac{\partial x}{\partial a} \right)_{b,c} \left(\frac{\partial x}{\partial c} \right)_{a,b} \sum \frac{da_i dc_i}{N-1} \\
&\quad \left. + 2 \left(\frac{\partial x}{\partial b} \right)_{a,c} \left(\frac{\partial x}{\partial c} \right)_{a,b} \sum \frac{db_i dc_i}{N-1} \right)^{1/2} \\
&= \left(\left(\frac{\partial x}{\partial a} \right)_{b,c}^2 \sigma_a^2 + \left(\frac{\partial x}{\partial b} \right)_{a,c}^2 \sigma_b^2 + \left(\frac{\partial x}{\partial c} \right)_{a,b}^2 \sigma_c^2 + 2 \left(\frac{\partial x}{\partial a} \right)_{b,c} \left(\frac{\partial x}{\partial b} \right)_{a,c} \sigma_{a,b} \right. \\
&\quad \left. + 2 \left(\frac{\partial x}{\partial a} \right)_{b,c} \left(\frac{\partial x}{\partial c} \right)_{a,b} \sigma_{a,c} + 2 \left(\frac{\partial x}{\partial b} \right)_{a,c} \left(\frac{\partial x}{\partial c} \right)_{a,b} \sigma_{b,c} \right)^{1/2}
\end{aligned}$$

Equation 26

If parameters are independent, covariance terms are zero, and Equation 26 becomes

$$\sigma_x = \sqrt{\left(\frac{\partial x}{\partial a} \right)_{b,c}^2 \sigma_a^2 + \left(\frac{\partial x}{\partial b} \right)_{a,c}^2 \sigma_b^2 + \left(\frac{\partial x}{\partial c} \right)_{a,b}^2 \sigma_c^2}$$

Equation 27

Equation 27 correspond to Equation 22 for x as defined by Equation 23.

Assuming all the parameters are independent, Equation 22 and Equation 1 may be used to develop rules for calculating the standard deviations and uncertainties of the mathematical operations. This is delineated in the following sections.

9.3.1 UNCERTAINTY OF MULTIPLICATION AND DIVISION

Consider x defined as

$$x = \frac{a \cdot b}{c}$$

Equation 28

The standard deviation of x may be calculate using Equation 22 as follows

$$\frac{\sigma_x}{x} = \sqrt{\left(\frac{\sigma_a}{a}\right)^2 + \left(\frac{\sigma_b}{b}\right)^2 + \left(\frac{\sigma_c}{c}\right)^2}$$

Equation 29

Inserting Equation 1 into above equation leads to a rule for calculating the uncertainty of multiplications and divisions:

$$U_x = \sqrt{(U_a)^2 + (U_b)^2 + (U_c)^2}$$

Equation 30

9.3.2 UNCERTAINTY OF ADDITION AND SUBTRACTION

Consider x defined as

$$x = a + b - c$$

Equation 31

The standard deviation of x may be calculate using Equation 22 as follows

$$\sigma_x = \sqrt{\sigma_a^2 + \sigma_b^2 + \sigma_c^2}$$

Equation 32

Inserting Equation 1 into above equation leads to a rule for calculating the uncertainty of additions and subtractions:

$$U_x = \frac{\sqrt{(U_a \cdot a)^2 + (U_b \cdot b)^2 + (U_c \cdot c)^2}}{a + b + c}$$

Equation 33

9.3.3 UNCERTAINTY OF COMBINED OPERATIONS

The standard deviation and uncertainty when mathematical operations are combined shall be calculated using Equation 22 in the same fashion demonstrated above. For example, consider

$$x = a \cdot b$$

Equation 34

where

$$a = \alpha + \beta$$

Equation 35

The standard deviation of x using Equation 22 is calculated as

$$\frac{\sigma_x}{x} = \sqrt{\left(\frac{\sigma_a}{a}\right)^2 + \left(\frac{\sigma_b}{b}\right)^2} = \sqrt{\left(\frac{\sqrt{\sigma_\alpha^2 + \sigma_\beta^2}}{\alpha + \beta}\right)^2 + \left(\frac{\sigma_b}{b}\right)^2}$$

Equation 36

To obtain the uncertainty of x , Equation 1 shall be inserted into the above equation, which leads to

$$U_x = \sqrt{\left(\frac{\sqrt{(U_\alpha \cdot \alpha)^2 + (U_\beta \cdot \beta)^2}}{\alpha + \beta}\right)^2 + (U_b)^2}$$

Equation 37

10 APPENDIX - LEAK FACTORS BY SECTOR

Figures Figure 25 to Figure 37 in this appendix provide a graphical comparison of the average emission factors by sector for compressor rod-packings, connectors, control valves, meters, open-ended lines, PRV/PSVs, pump seals, regulators, SCVFs, and thief hatches respectively. Each figure presents bars showing the average emission factor, whisker plots of the 95 percent confidence limits plus the number of components surveyed. In all cases, the confidence limits for the oil and gas sector overlap so distinguishing separate sector factors is not necessary (EPA, 1995) and the value corresponding to “All” sectors should be applied by users.

To support the combination of records into a single sector population, one-way analysis of variance (ANOVA method) is used to confirm there is no statistically significant difference between the means of these two independent groups. This test is conducted by considering “sector” as the main factor of the analysis with two levels (Oil and Gas). Each level is assigned 12 leak rate “responses” as delineated in Table 22 which correspond to the component types identified in this study.

Table 22: Arrangement of data for one-way ANOVA testing.^a		
Response Categories (Component – Service)	Sector Factor (kg/hr)^a	
	Level 1 (Oil)	Level 2 (Gas)
Compressor Seal - Process Gas	0.761199	0.167356
Connector - Process Gas	0.000191	0.000116
Control Valve - Process Gas	0.00962	0.003012
Meter - Process Gas	0.00039	0.001493
Open-ended Line - Process Gas	0.011516	0.096298
PRV/PSV -Process Gas	0.007561	0.001527
Pump Seal - Process Gas	0.020611	0.002614
Regulator - Process Gas	0.001543	0.000769
SCVF - Process Gas	0.007103	0.17126
Valve - Process Gas	0.000089	0.000623
Connector - Light Liquid	0.000007	0.000007
Valve - Light Liquid	0.000209	0.000023

^a Thief hatch is excluded as no data is available for the gas sector.

The results of ANOVA testing are presented in Table 23 and indicate the null hypothesis is true, and the true means of the populations are the same. This means the difference between the observed means and the variation between the data in the oil and gas sectors are caused only by random error. Thus, a single factor for each component type with sector = “All” is presented in Section 3 Table 9 and Table 10.

Table 23 summarizes sum of squares, degree of freedom, and mean of square as well as the output of F-test in terms of F , F critical, and P -value. The results reflect the variation of data within and between the levels. Moreover, they provides F-test outputs that assess the null hypothesis that the population means are equal. F critical is calculated to be 4.3 when a significance level of 0.05 is considered, while F value of the test is only 0.22. As F is much smaller than F critical, the null hypothesis cannot be rejected. Additionally, F corresponds to a P -value of 0.64, which is much higher than the significance level so the null hypothesis cannot be rejected.

Table 23: Results of ANOVA.						
Source of Variation	Sum of Squares (SS)	Degree of Freedom (df)	Mean Square (MS)	F	P-value	F critical
Between Levels	0.005858	1	0.005858	0.2244	0.6404	4.3009
Within Levels	0.5742	22	0.02610			
Total	0.5801	23				

The following assumptions are made to perform the ANOVA test:

1. Responses and observations are chosen randomly and independently.
2. The levels have a common variance.
3. The distributions of the residuals are normal.

The first assumption is true based on the observations in the study were made. The second assumption also was shown to be true by F test. The last assumption is not true since the distributions are skewed; however, as long as number of observation are sufficiently large, the normality can be violated if the distributions have similar shape.

No-leak factors are also presented below to illustrate their contribution to fugitive emissions for each component type. No-leak factors are less important for component populations featuring lots of leaks but as fewer and smaller leaks are detected, the no-leak contribution to total fugitive emissions becomes more important. This is the case for connectors and valve where the no-leak factor is actually greater than the population average factor. In fact, the no-leak contribution to total fugitive emissions from connectors and valves is approximately 74 percent.

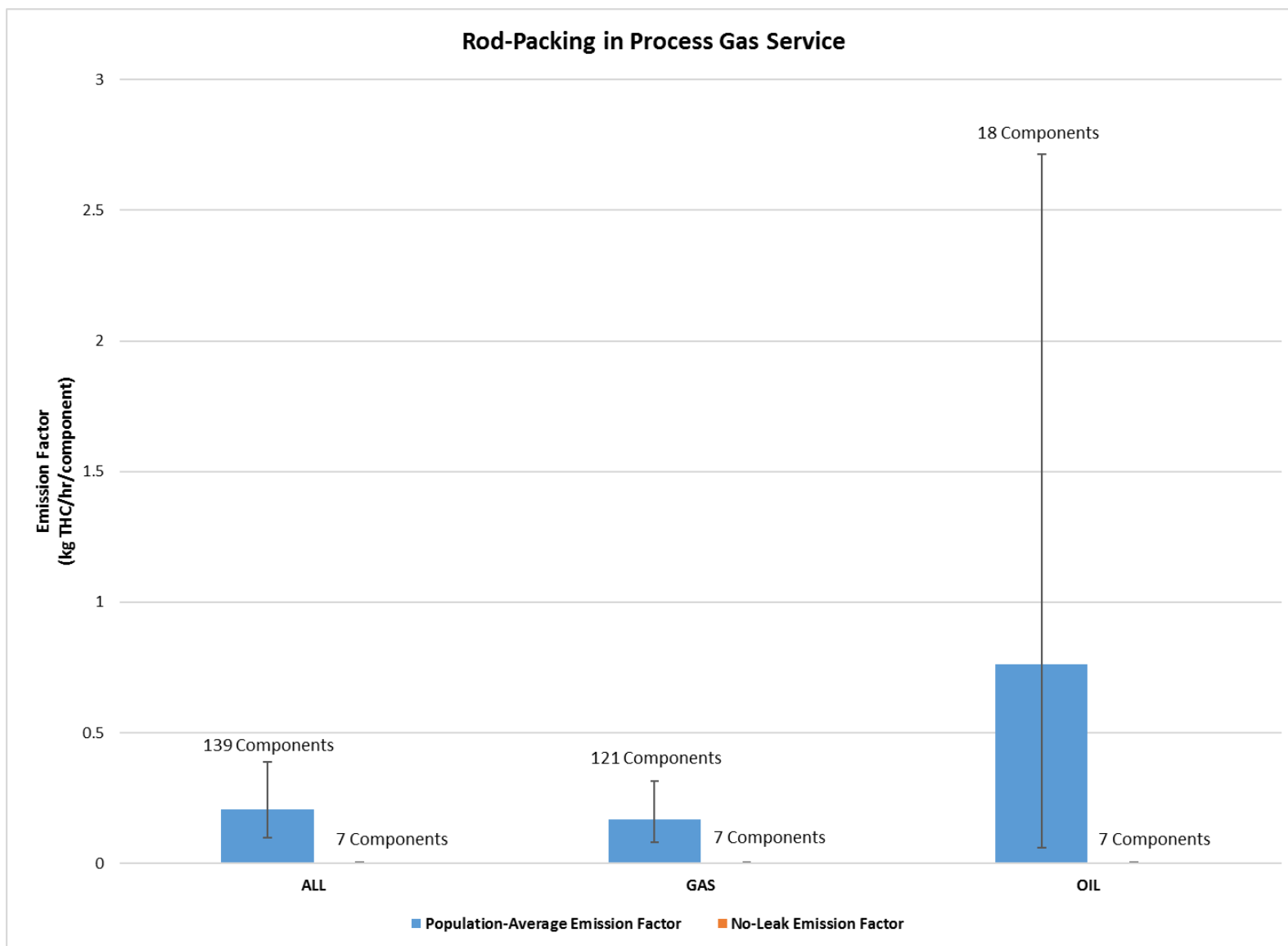

Figure 25: Population-average leak rates for rod-packings in process gas service by sector.

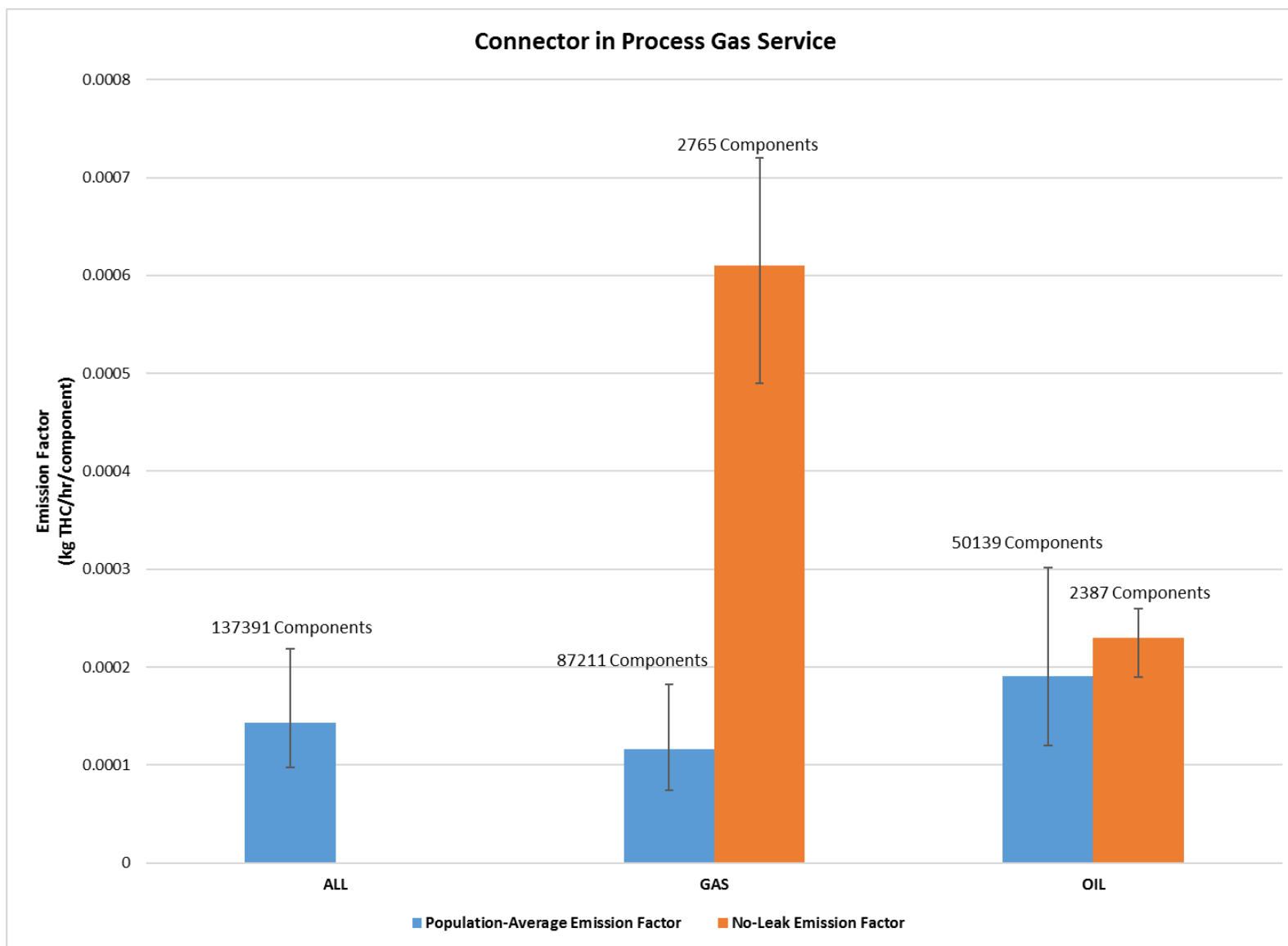

Figure 26: Population-average leak rates for connectors in process gas service by sector.

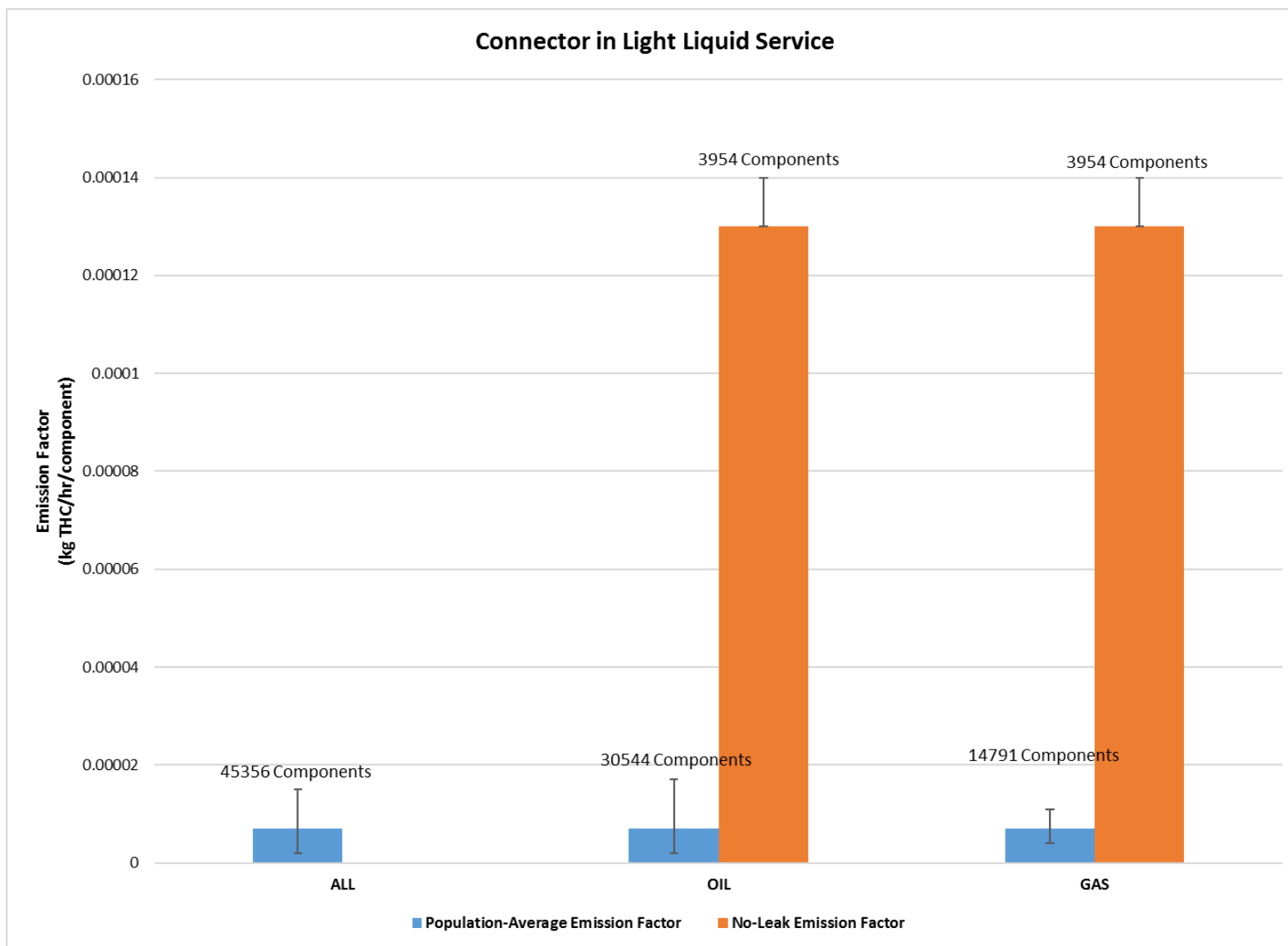

Figure 27: Population-average leak rates for connectors in light liquid service by sector.

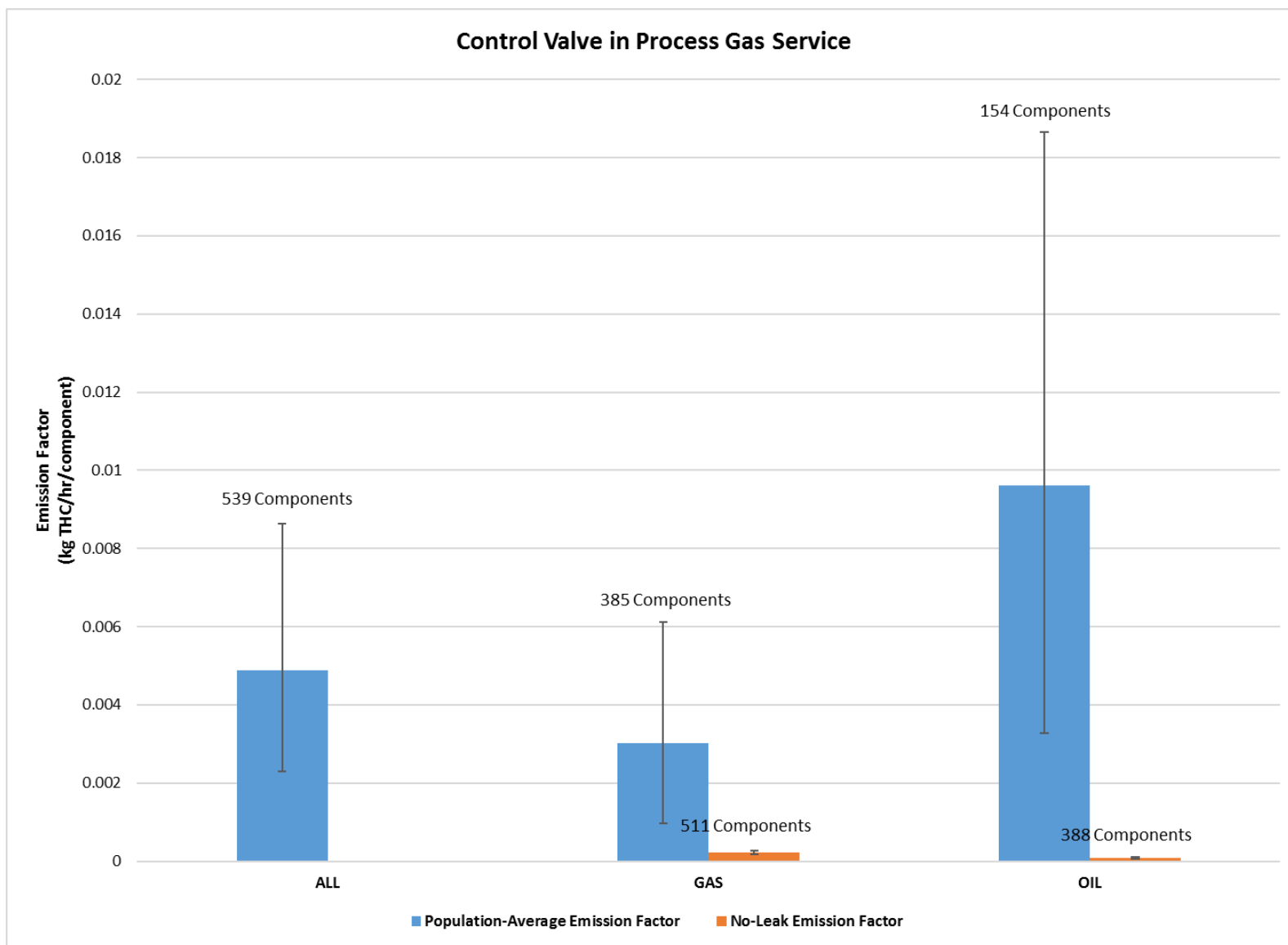

Figure 28: Population-average leak rates for control valves in process gas service by sector.

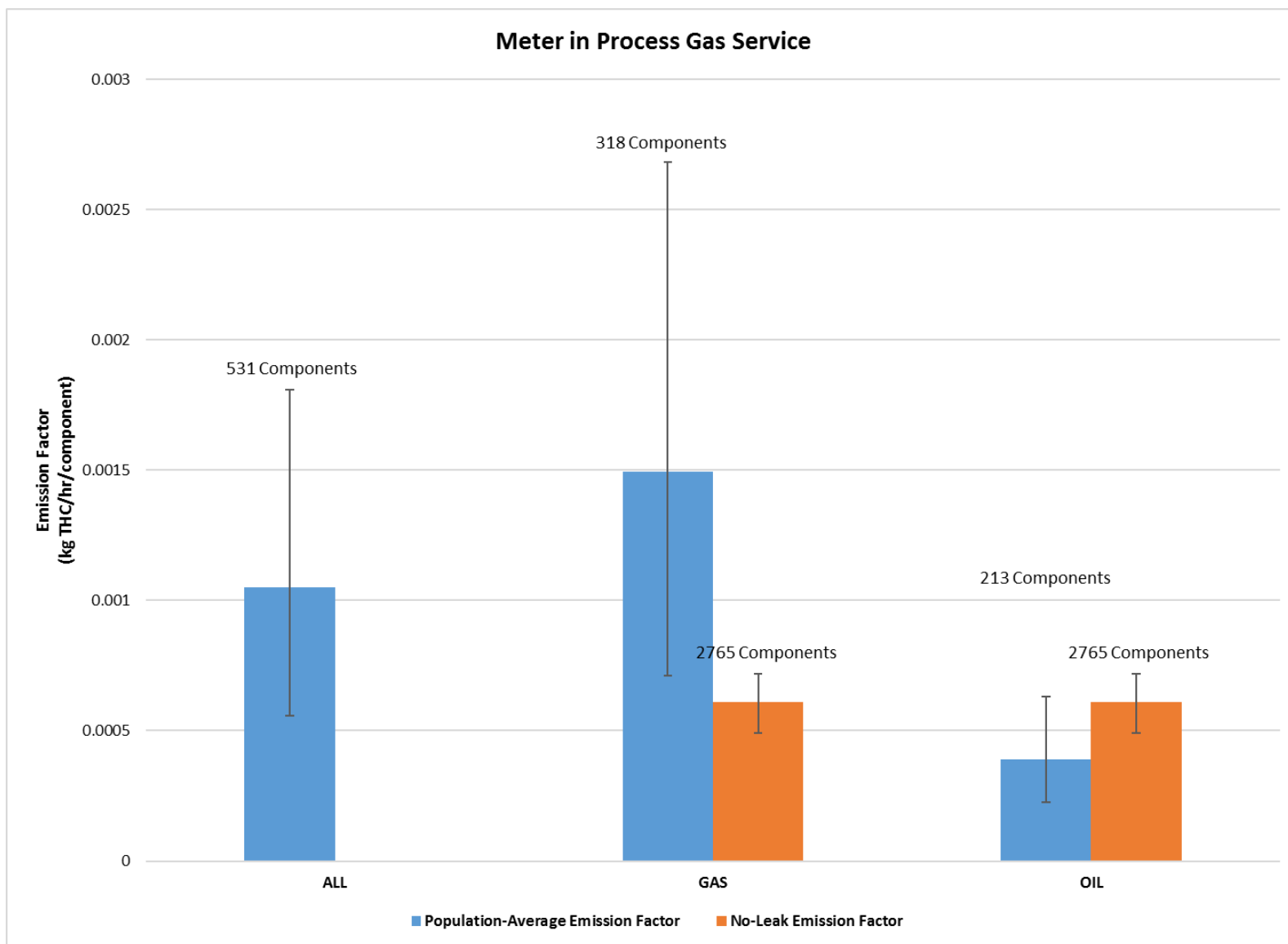

Figure 29: Population-average leak rates for meters in process gas service by sector.

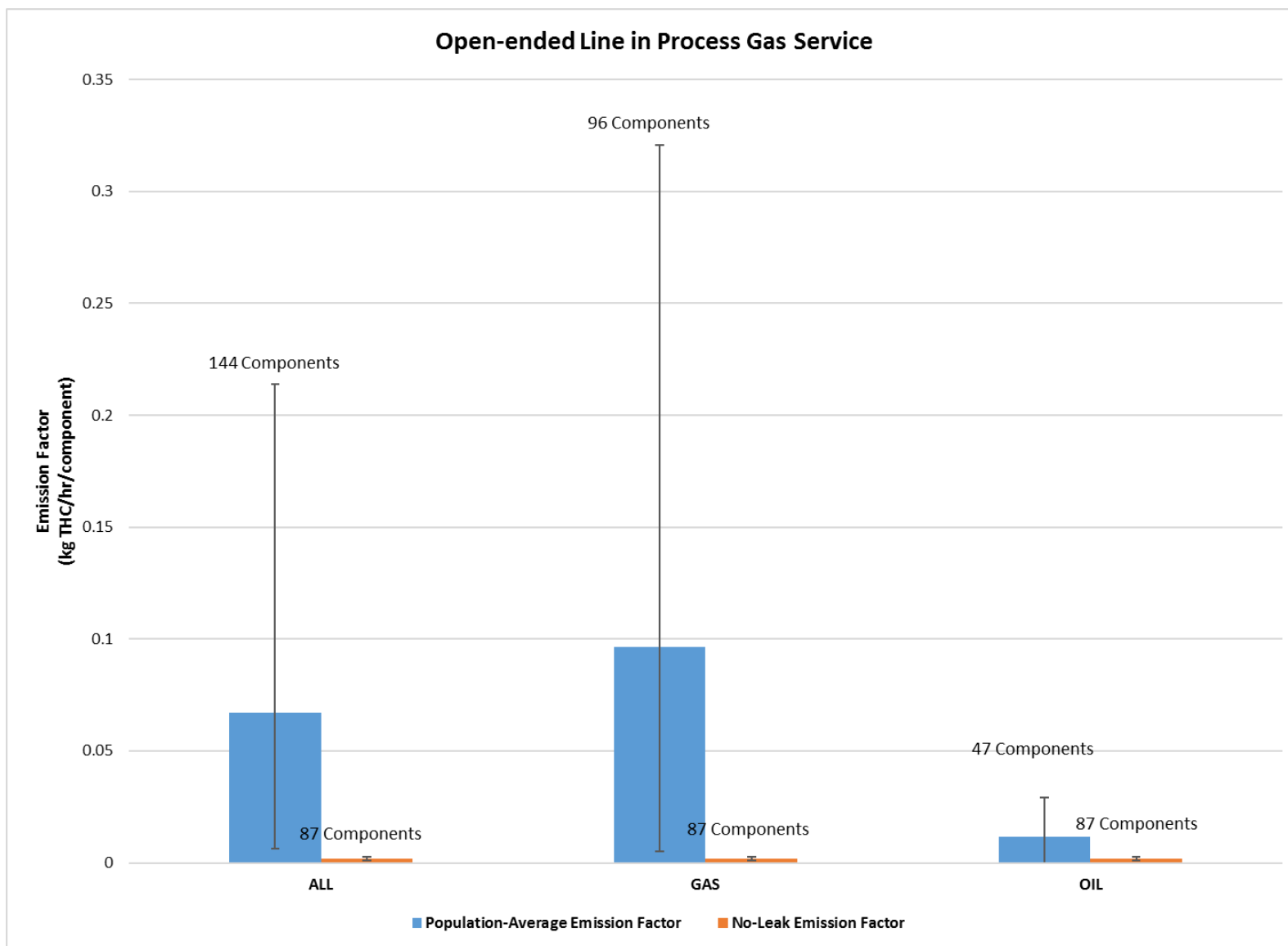

Figure 30: Population-average leak rates for open-ended lines in process gas service by sector.

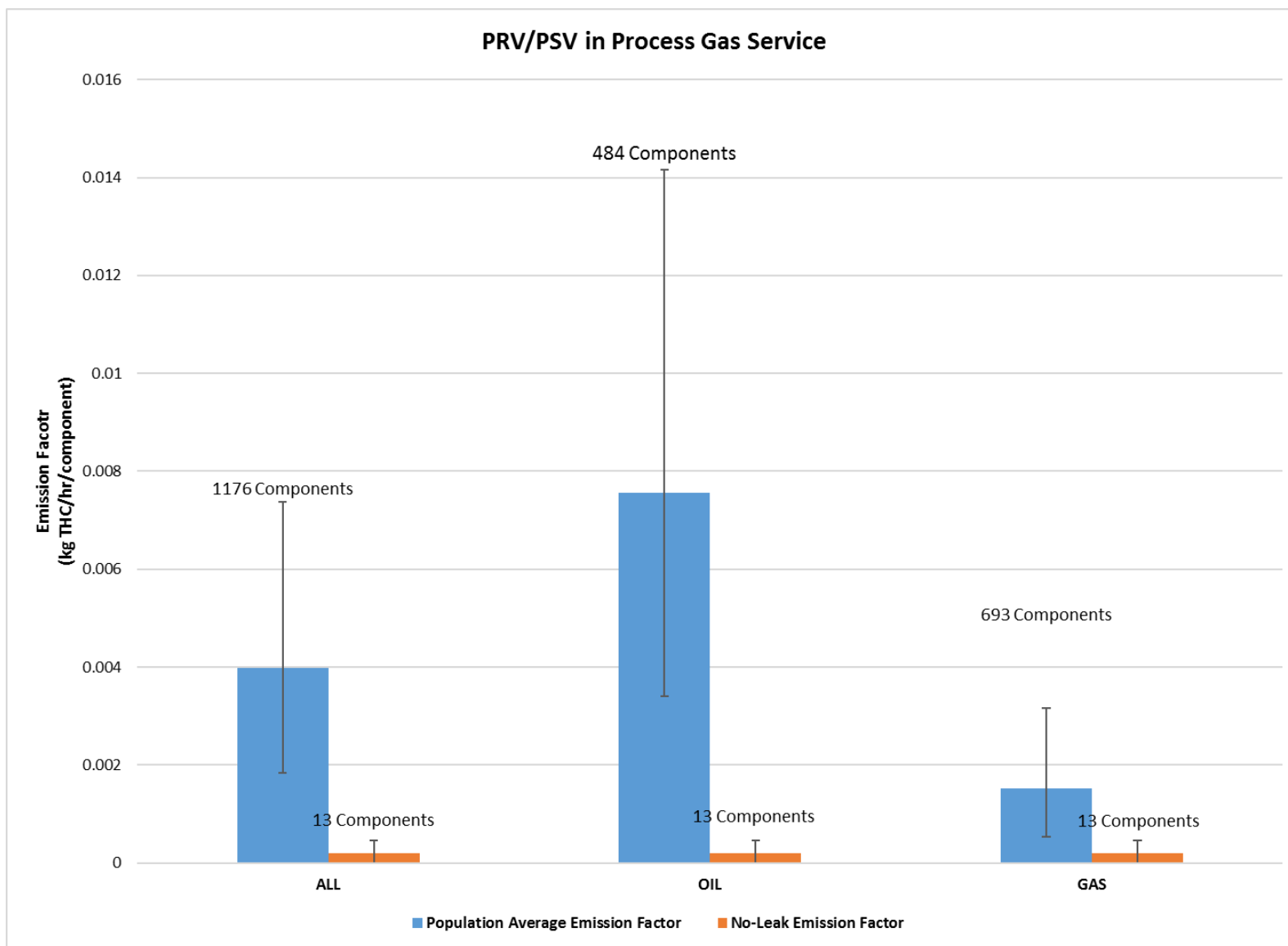

Figure 31: Population-average leak rates for PRV/PSVs in process gas service by sector.

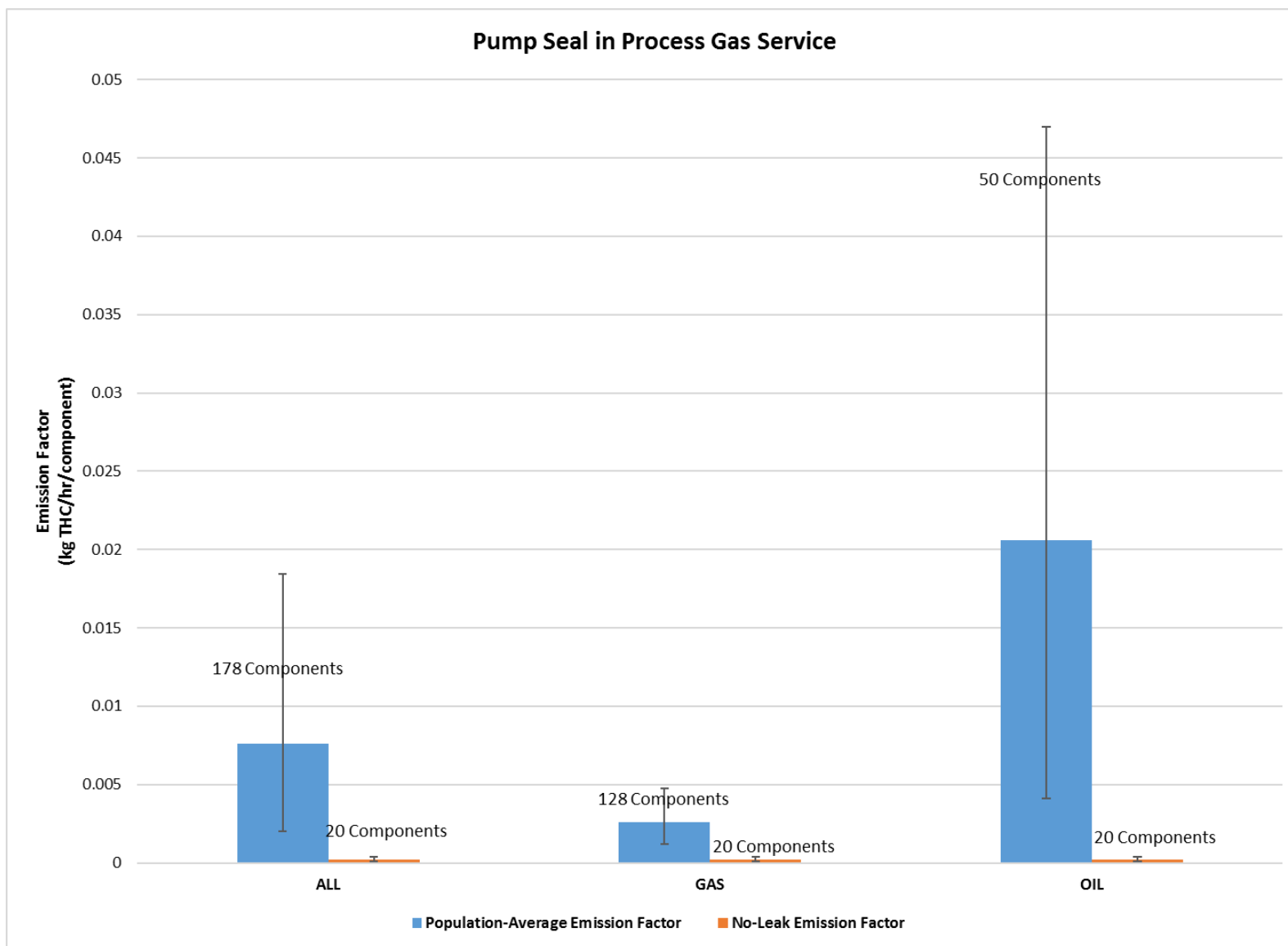

Figure 32: Population-average leak rates for pump seal in process gas service by sector.

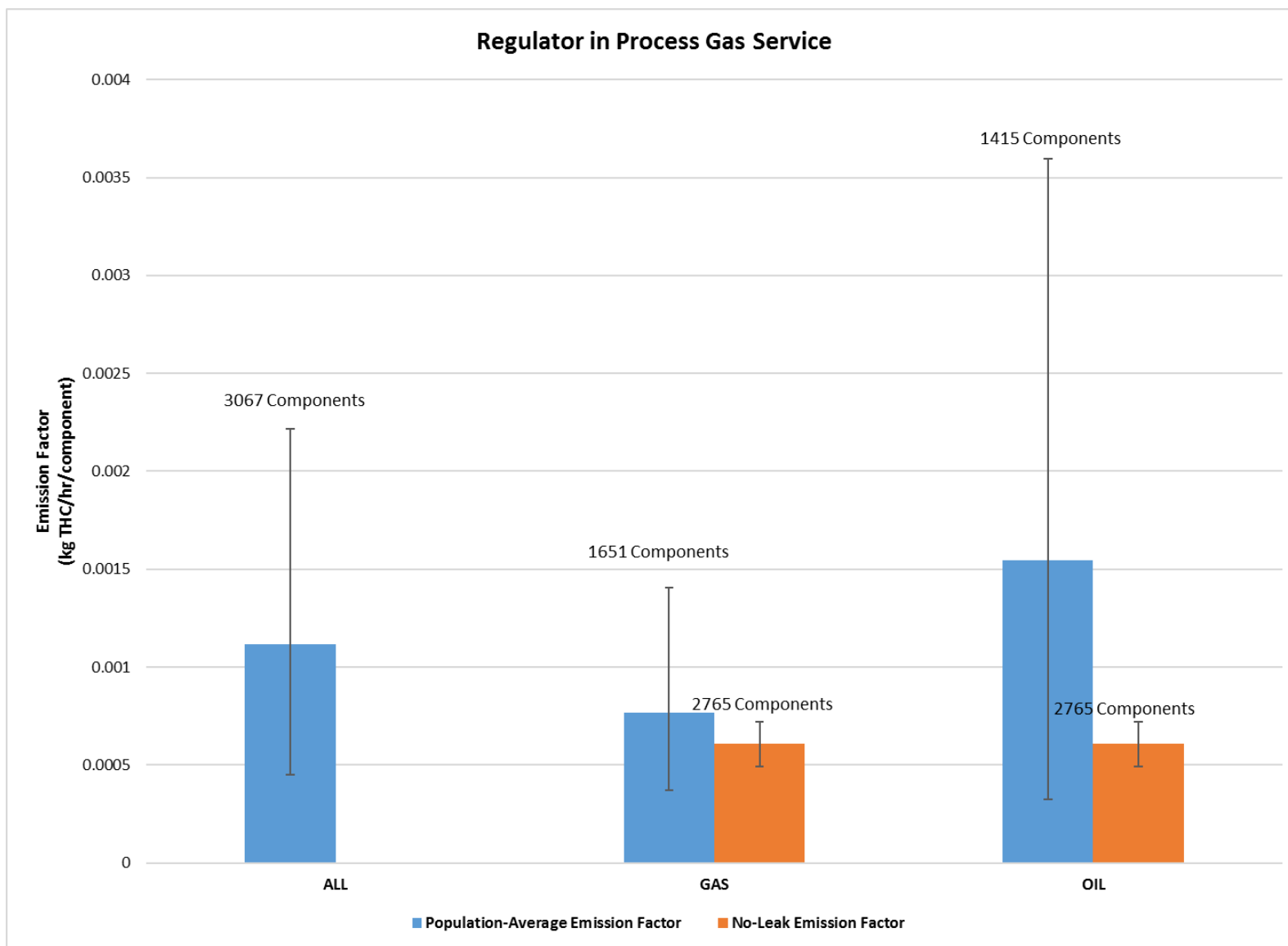

Figure 33: Population-average leak rates for regulators in process gas service by sector.

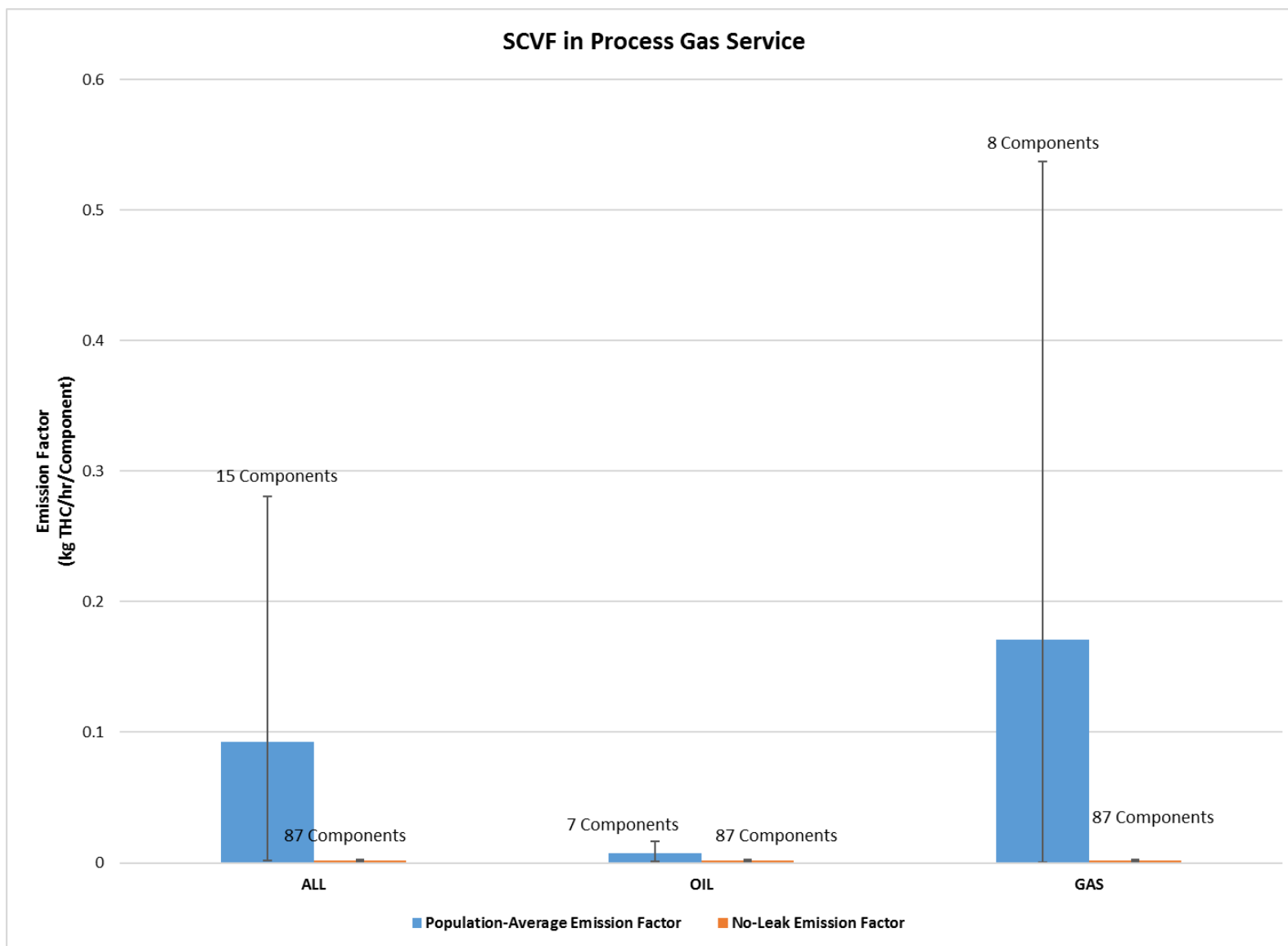

Figure 34: Population-average leak rates for SCVFs in process gas service by sector.

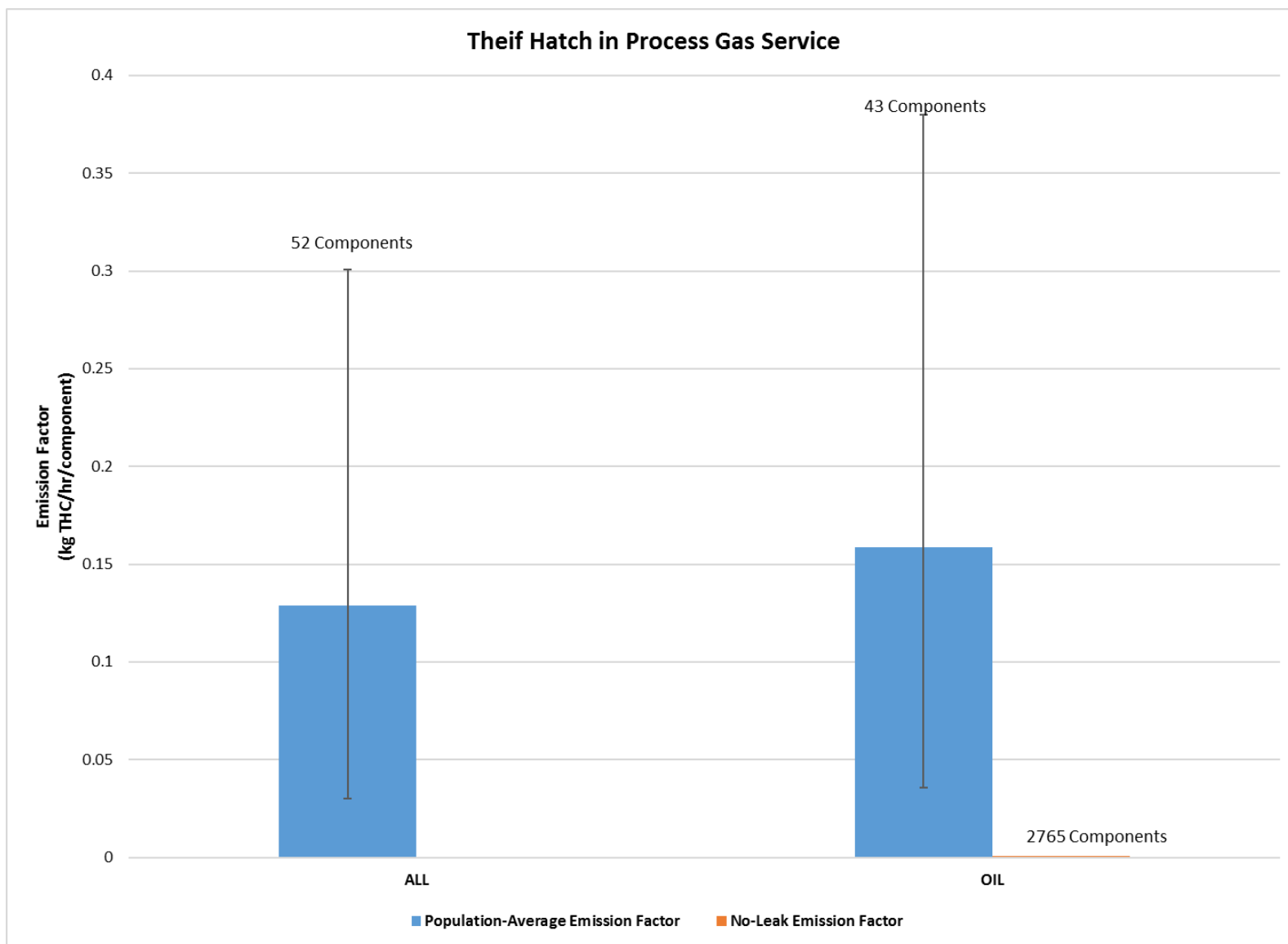

Figure 35: Population-average leak rates for thief hatches in process gas service by sector.

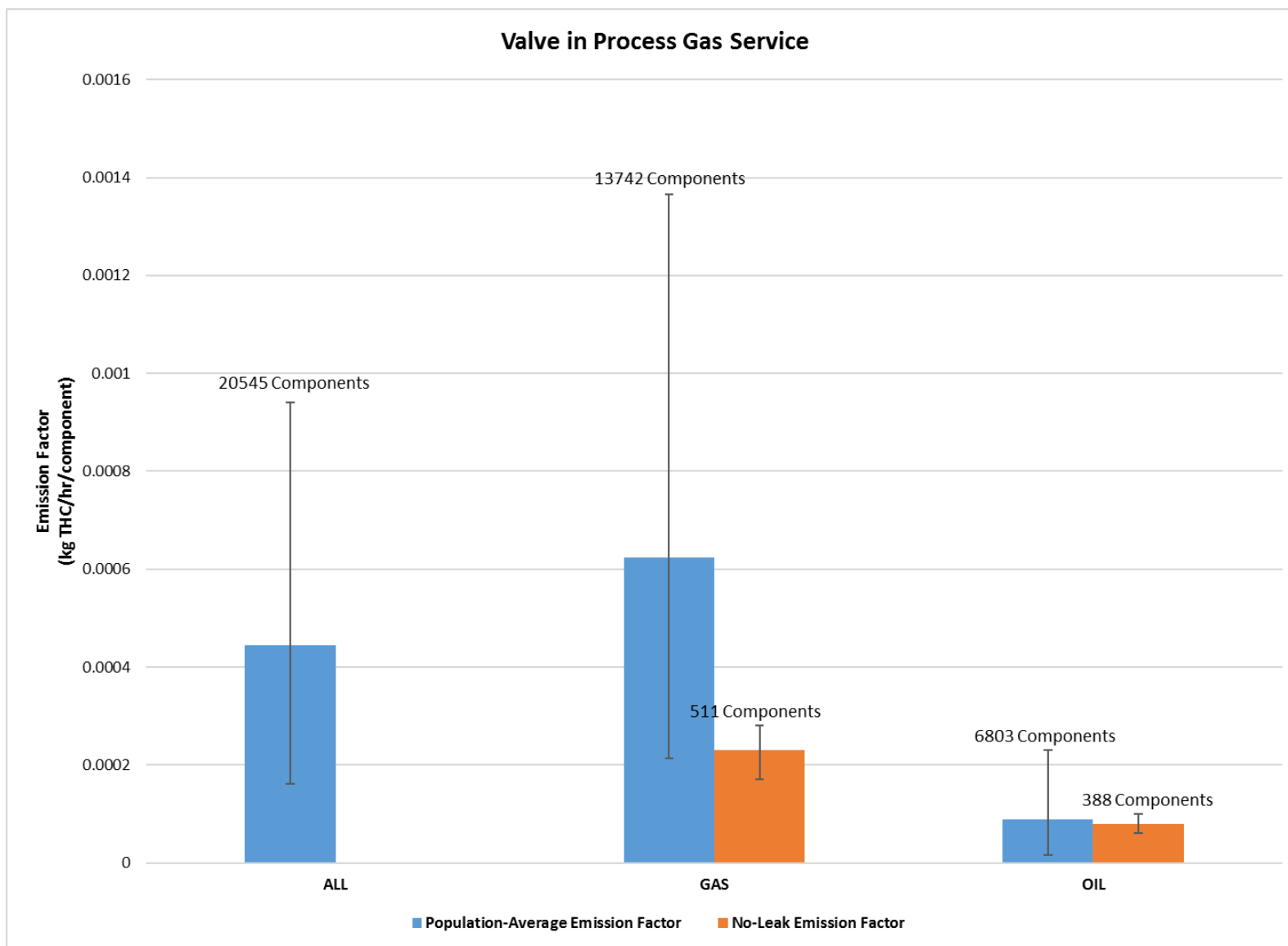

Figure 36: Population-average leak rates for valves in process gas service by sector.

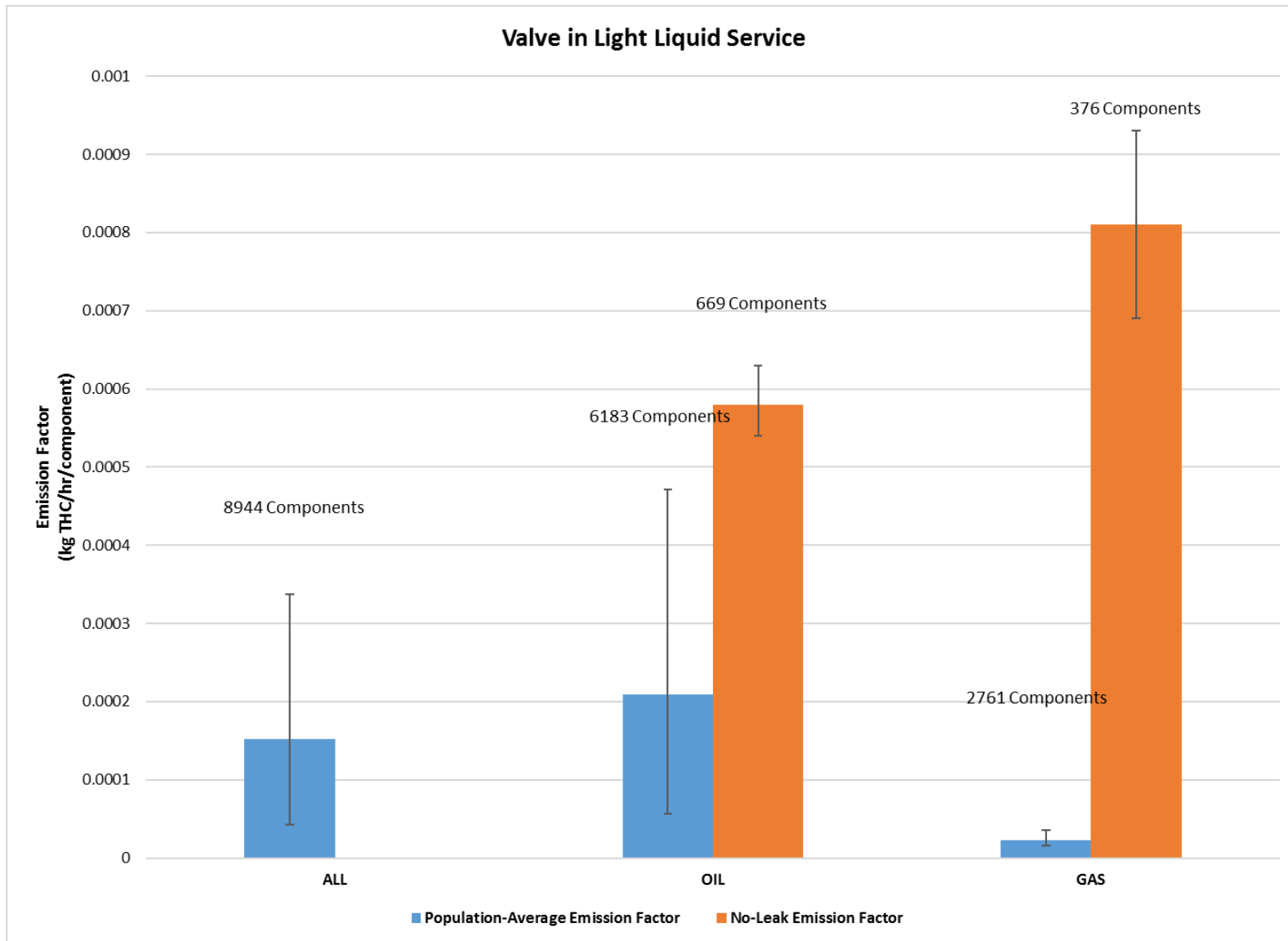

Figure 37: Population-average leak rates for valves in light liquid service by sector.

11 APPENDIX - RAW DATA (BLINDED)